



Q3

Audi Q3



Dialogue: Audi QR codes

Experience Audi even more directly: download a QR app to your smartphone and then scan the QR code or follow the given link in your browser.



The equipment for the vehicle illustrated in the Fascination section can be found on page 99.
The fuel consumption and CO₂ emission figures can be found from page 88 onwards.

	Page	
Fascination		
	4	Audi Q3
Technology		
	24	Innovations
	26	Audi ultra
	28	Audi connect
	30	quattro®
	32	Performance
	34	Dynamics
	36	Assistance systems
	38	Complexity
	40	LED headlights
Equipment		
	44	Style guides
	46	Audi ultra
	48	Engines
	50	Equipment lines
	56	S line
	58	Audi exclusive
	62	Paint finishes
	64	Wheels/tyres
	66	Seats/seat upholstery
	70	Inlays
	72	Lights
	73	Design
	74	Steering wheels/controls
	75	Comfort
	78	Infotainment
	80	Assistance systems
	83	Technology/safety
	83	Audi Extended Warranty
Other		
	84	Audi Genuine Accessories
	88	Technical data
	93	Dimensions
	94	Index
	100	The fascination of Audi

The Audi

Q3

**En route
to myself.**

Here today, there tomorrow. The world is getting smaller. And your possibilities become more varied. With a car that keeps up with your demands – the new Audi Q3. Powerful and agile. Compact and yet spacious inside. And on top of that, expressive, efficient and sporty.

The Audi Q3. Built from new expectations. Let's go.

The fuel consumption and CO₂ emission figures can be found from page 88 onwards.





Modern mobility confidently interpreted. The new Audi Q3 makes an impression. With the striking Singleframe in 3D design. Low-set air inlets in the bumper. And horizontal lines that make the vehicle appear even more powerful. Clearly the styling of an SUV. Combined with coupé-like design. Unique and progressive. Exuding power and sportiness. Right up to the diffuser and the chrome-plated tailpipe trims.





Athletic appearance in pioneering design. Making a progressive impression. Optionally with redesigned LED headlights and rear lights. Including dynamic indicators at the rear. Details that convey urban sportiness. Through and through. With seven new attractive wheel designs. And even more options for an individual appearance.

On request with the new equipment lines Q3 sport and Q3 design. Each with exclusive 17-inch cast aluminium wheels. Magnificent prospects. Thanks to the optional panoramic glass sunroof even when looking up.





**En route
to**

driving enjoyment.

Get in and drive away. Setting your sights on new destinations. Feel the forward thrust. In the new Audi Q3, TFSI and TDI engines of the latest generation will be driving you forward. Completely redesigned. From 88 to 162 kW and at top speeds of up to 233 km/h. Accompanied by high torque output and thrilling engine power. Power increased. Efficiency too. Thanks to the start-stop system and recuperation, among other things. And Audi cylinder on demand technology in the Audi Q3 1.4 TFSI ultra. Fuel saved, emission reduced.

During every trip. Go on.



To see the Audi Q3 in action, just scan this QR code using your smartphone (connection costs depend on your mobile phone contract). Or follow this link in your browser: www.audi.com/q3film



The fuel consumption and CO₂ emission figures can be found from page 88 onwards.



The fuel consumption and CO₂ emission figures can be found from page 88 onwards.



**En route
to
excellence.**



The fuel consumption and CO₂ emission figures can be found from page 88 onwards.

The challenges of the city. Tight bends, long straights. Driving situations that change in an instant. Mastered with confidence through proven Audi technologies. For example with the quattro permanent all-wheel drive. For more traction in any type of weather. Optimum distribution of the drive force to the front and rear axle. And with it, driving enjoyment that sticks. In your mind and to any road. Additionally, quick gear changes with the S tronic 7-speed dual-clutch transmission. And for your individual driving style from sporty to efficient: Audi drive select with four modes and damper control. In addition, comprehensive driver and park assist systems that turn any city into your territory.





En route to feeling comfortable.

The interior of the new Audi Q3. High-class down to the last detail. And on request with your own personal touch. Thanks to the new equipment lines Q3 sport and Q3 design – each with its own inlays. Staged impressively by the optional LED interior lighting package. State-of-the-art infotainment technology with optional MMI navigation plus. Optional connectivity package with integrated Bluetooth interface, preparation for navigation system and Audi music interface. A pleasure for the ears: the optional Bose surround sound system with 14 high-performance loudspeakers.

Allowing you to feel truly comfortable when you are on the road. Almost as if you were at home.

The fuel consumption and CO₂ emission figures can be found from page 88 onwards.





Sit down. On comfortable seats made of fine cloth. Or on request made of premium leather. Enjoy the classy ambience. And a lot of spaciousness for your personal life style. From practical storage compartments to the comfort of plenty of legroom. Generosity of scale is also evident in the luggage space. With even more loading capacity by folding the rear seat bench. Thanks to the extendable luggage compartment cover and optional electrical tailgate, loading is also very comfortable.



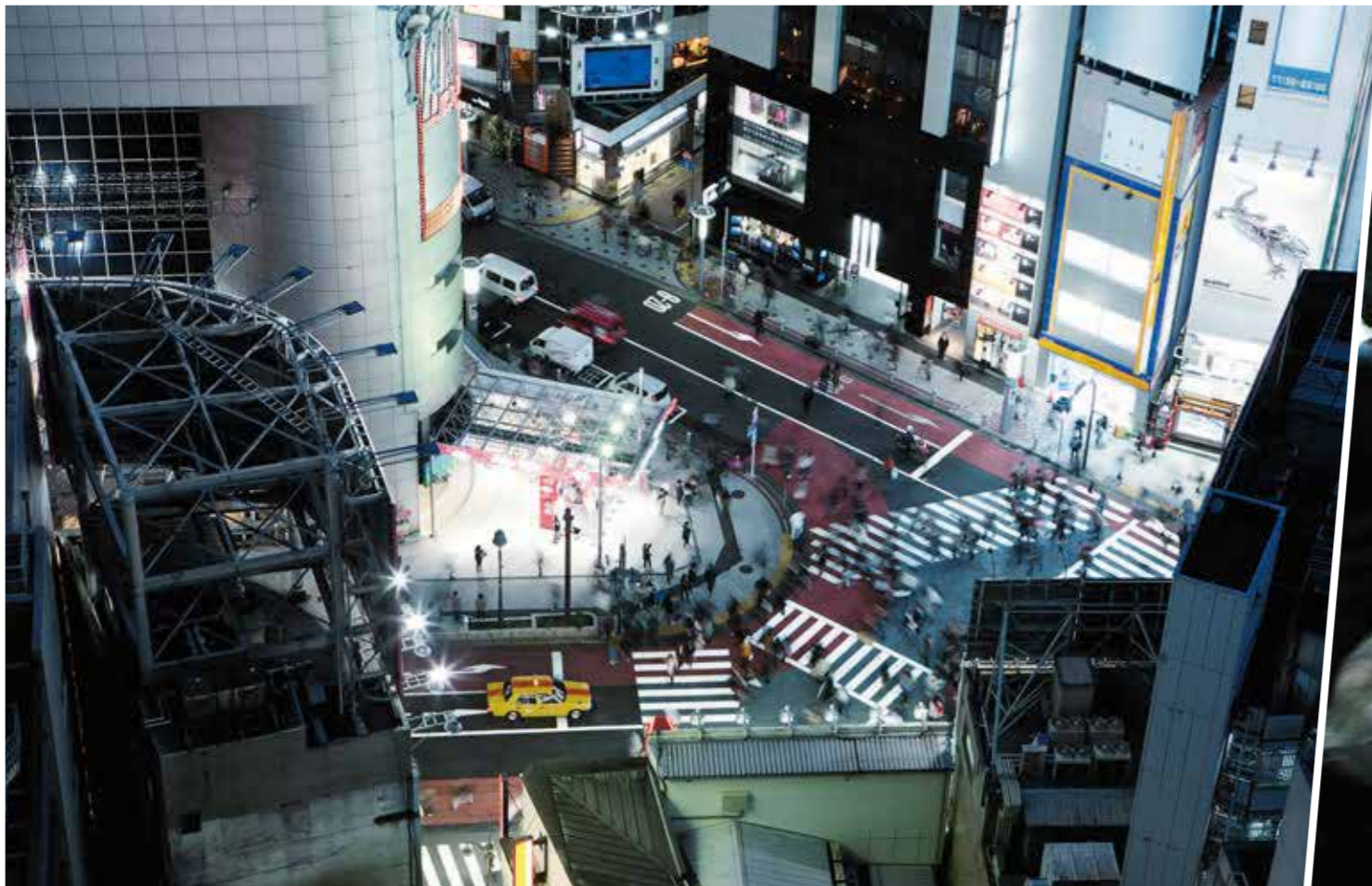

Destination reached. Confident and relaxed. And still brimming with energy. Because combining quattro with impressive performance makes the journey the ultimate destination. Experience the height of driving enjoyment again and again.

In the new Audi Q3.

The fuel consumption and CO₂ emission figures can be found from page 88 onwards.



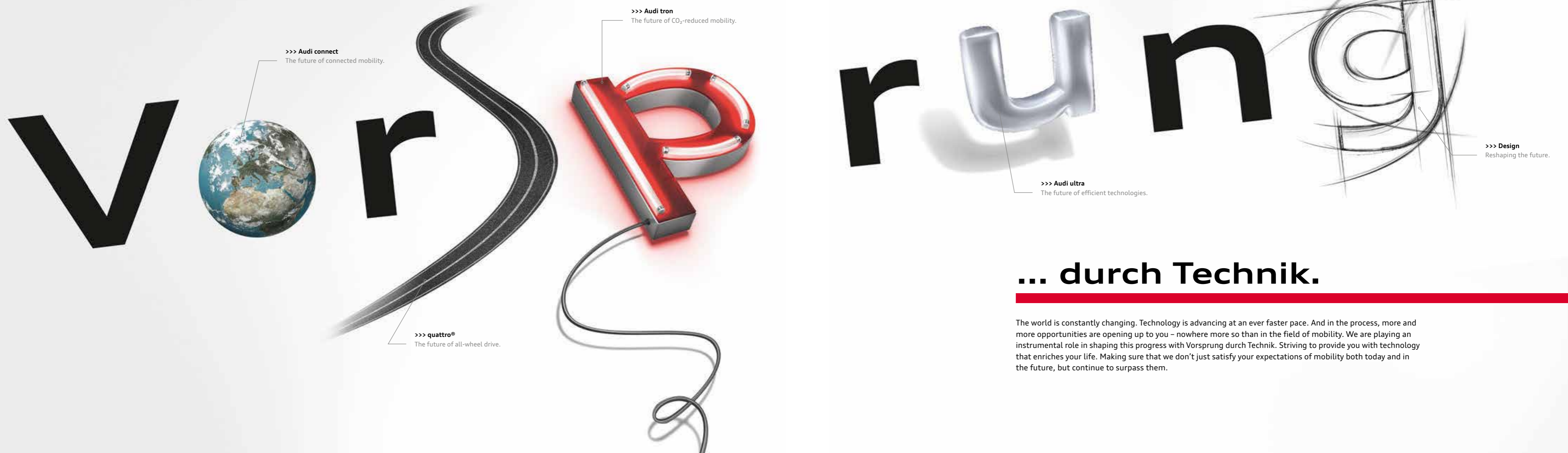

Audi ultra

Perfectly combined.

The future of efficient technologies.

Building an Audi is an extremely complicated business. And yet a simple principle applies for all models: all vehicle components interlock precisely in order to produce emission-reducing synergies. What started in accordance with this principle at the end of the 1980s with Audi lightweight construction and the revolutionary Audi Space Frame (ASF®) is now known as the reversal of the weight spiral: every lightweight component has an impact on other components, which can in turn be made smaller. In this way, existing forms and materials are continuously being improved with regard to their functionality, the lowest possible weight and their production process. With the goal of building vehicles that are even more efficient and make more sparing use of resources. At the same time, more and more efficiency technologies are being built into an Audi. These include recuperation and the start-stop system. Not to mention progressive, efficient high-tech engines. For greater driving dynamics, high compression, more efficient combustion and lower CO₂ emissions. All this is known as Audi ultra. Today and in the future – towards CO₂-reduced mobility.

>>> Aerodynamics

Less drag, more efficiency. Thanks to the consistently aerodynamic styling of the vehicle's lines, its underbody and spoiler edges – in order to achieve the best possible form for aerodynamic efficiency. Not forgetting tyres with reduced rolling resistance. All tested in the Audi wind tunnel at up to 300 km/h.

>>> Lightweight expertise

Less weight. More savings, power and endurance. Audi lightweight technology. What started with lightweight body construction has now made its way into nearly all areas, combining innovative materials such as aluminium, intelligent design principles and resource-saving manufacturing processes into an overall concept.

>>> Transmission expertise

Improved efficiency thanks to improved transmission ratios. A higher torque output makes longer ratios possible, especially in higher gears. For powerful torque in the low engine speed range which reduces consumption – yet has no adverse effects on driving performance and sportiness.

>>> Recuperation

Braking that leads to even more efficient driving. With brake energy recovery (recuperation). Part of the kinetic energy produced when braking and coasting is temporarily stored in the vehicle's battery and then used when accelerating. Depending on the driving cycle, this can save up to 3% of fuel.

>>> Engine expertise

Powerfully and efficiently driven. By Audi ultra with efficiency technologies in the engine sector. Such as Audi cylinder on demand and the Audi valvelift system, which both reduce the amount of energy consumed by the engine, or clean diesel technology, which can help to reduce emission.

Mobility & navigation

Point-of-interest (POI) search with voice control
in the Google™¹ database.



Traffic information online
Dynamic route guidance with real-time traffic flow information.



Country information²
displays the country-specific information, e.g. compulsory to carry a high-visibility vest or purchase a motorway sticker as well as maximum speeds, can be called up at the push of a button in MMI.



Fuel prices
The cheapest petrol stations at your destination or in the vicinity.

Communication

Wi-Fi hotspot
connects your mobile devices to the internet.



Parking information
Help with looking for car parks and multi-storées, plus – where available – information on prices and currently vacant spaces.



Navigation with Google Earth™¹ and Google Street View™¹
uses high-resolution aerial and satellite images, photos and address information to guide you to your destination even more easily.



Destination entry via myAudi or Google Maps™^{1,3}
If you want, you can plan your navigation destinations conveniently from your PC. myAudi and Google Maps™¹ allow individual navigation destinations to be sent to the vehicle. When you start your journey, these can easily be loaded as your destination.

myAudi – your personal control centre
provides you with password-protected access to www.audi.com/myaudi where, following one-off registration, you are able to manage the services supported by Audi connect and configure them from the comfort of your own home.

Audi connect.

Audi connect**The future of connected mobility.**

The world presents you with countless possibilities. The optional Audi connect enables you to make the most of many of them in digital form directly from your Audi. At the push of a button. Tailored to you. Thanks to myAudi and the services supported by Audi connect in your vehicle. In places all over the world. Intuitively, easily and conveniently.

Infotainment

Weather
Forecasts and maps for the required destination.



Audi music stream
Access to global radio stations via smartphone app and Wi-Fi, plus access to your smartphone's media library.



News online
Text and images about current world events.



Travel information
Sightseeing information – with a function for importing the destination to the navigation system.

Have the road completely under control, thanks to permanent distribution of the drive force to all four wheels. The rear axle is variably controlled via a hydraulic multi-plate clutch. Always as the situation demands, always selective. Experience handling stability, dynamism and agility as never before and combat the effects of over- and understeer with quattro. For increased traction and superior propulsive power. Tame any road. And always keep your eyes set on where you're heading. In bends. On straights. Over any surface. For a fascinating experience that sticks. To the road – and in your mind.



quattro®
**Stick to
the road.**

With quattro®.

Performance

Maximum power. Put to maximum use.

Every movement originates from something. Something that sets it off, an idea. The engine in your Audi Q3 can also be traced back to an initial spark of inspiration: higher power with lower fuel consumption. These apparently conflicting aims are reconciled in two revolutionary drive technologies: TDI and TFSI. Get acquainted with both of them. And then opt for the drive system that you feel most moved by.



The fuel consumption and CO₂ emission figures can be found from page 88 onwards.



TDI®

With their combination of direct injection and turbocharging, Audi TDI engines promise exceptional performance – thanks to their high torque output over the entire engine speed range with constant power build-up. They are renowned for being fuel-efficient and emission-reducing. But they are incredibly dynamic too – letting you get the maximum out of any road.



TFSI®

Audi TFSI engines attain a particularly high compression rate. The result: outstanding efficiency combined with optimum performance. Substituting supercharging for cubic capacity has the effect of considerably reducing engine size and weight – while performance remains as impressively dynamic as ever. For power delivery that will win you over from the word go.

Audi cylinder on demand.

Even cylinder heads can be intelligent, as Audi cylinder on demand proves. Cylinders two and three of the 4-cylinder TFSI engine automatically shut down in the partial-load range. This helps to lower fuel consumption at the same time as reducing the emission. Without the switchover even being noticed or impairing the driving dynamics.

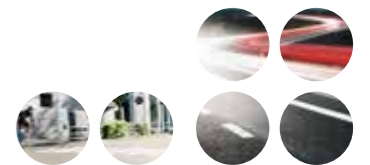

>>> S tronic®

The sporty, efficient dual-clutch transmission allows you to switch gears with lightning speed without a noticeable break in propulsive power.

>>> Suspension with comfortable tuning

This suspension tuning allows agile handling and provides impressive driving dynamics.

>>> Audi drive select

Audi drive select lets you adjust the driving characteristics of the Q3 to suit your requirements. At the push of a button. Sportier, more comfortable, more balanced or more economical. It's entirely up to you.

>>> 4-link rear axle

with separate spring/damper arrangement.

>>> Electromechanical power steering

The speed-sensitive power steering conveys a precise steering feel even at high speeds, helps you to countersteer and makes light work of parking.

>>> quattro®

The permanent all-wheel drive distributes the drive forces to each individual wheel for more traction and dynamism depending on the driving situation.

Dynamics

Dynamics

that will take hold of you.

Get in. Buckle up. Start the engine. Wherever you're heading, enthralling driving dynamics will power you there. For as you know, the world is your oyster once you get behind the wheel of your Audi Q3. You decide the direction. The driving style. The pace. And you enjoy the satisfaction of knowing you have plenty in reserve. More than enough to get the very best from every drive.

The fuel consumption and CO₂ emission figures can be found from page 88 onwards.

You can find out which equipment features are available as standard or optional in your model by referring to the index starting on page 94.

Assistance systems

Wherever you're heading, peace of mind will be your constant companion.

With the assistance systems in your Audi.

Each drive is different. Yet they all have one thing in common – the feeling of being protected that you get from every Audi. All driver assistance systems in your Audi Q3 help you during your journey and guarantee even greater comfort when you're on the road. Get to know the most important driver assistance systems.

>>> **Camera-based recognition of traffic signs**
detects overtaking bans and speed limits and informs you via the driver information system.

>>> **Audi side assist**
monitors traffic behind the vehicle and helps you when changing lanes.

>>> **Audi active lane assist**
helps you to keep in lane by means of gentle steering intervention when lane boundary markings are detected.

>>> **Parking system plus with reversing camera**
provides a better overview for parking and manoeuvring by showing visual display of the surroundings in front and behind the vehicle and optional camera image including dynamic guidelines for the rear area

>>> **Park assist**
supports comfortable parking and leaving a parking space by temporarily performing steering actions.

>>> **Cruise control**
keeps any speed set over 30 km/h more or less constant and thus helps ensure a safe and relaxed drive.

>>> Audi connect

Use all of the optional services supported by Audi connect with MMI navigation plus – quickly and conveniently. The intuitive operation of the MMI makes access to many internet-based functions remarkably straightforward.

>>> Navigation

With MMI navigation plus you can let yourself be guided to your destinations with even greater ease by means of a 3D map view and 3-dimensional display of places of interest and landmark buildings.

>>> Car

Control and alter driver assistance systems, vehicle settings as well as climate control and service functions quickly and easily using the MMI.

>>> Media

Display the covers of your music collection on all available media sources such as jukebox, inserted SD cards, Audi music interface, CDs or DVDs.

>>> Phone

Make phone calls safely and easily using the hands-free facility: simply select the number to dial from your contacts in the MMI or enter the number intuitively via the MMI.



y

u

**Simplicity****The MMI® – intelligent, individual, intuitive.**

Streamlined. Simple. Logical. The world of mobile infotainment completely redefined: the Multi Media Interface (MMI). Phoning, navigating or surfing the internet via Audi connect: all highly intuitive, highly functional and highly convenient – not least thanks to voice control. With the MMI in your Audi Q3, everything will be child's play for you.



LED headlights

Bright lights



State-of-the-art LED technology. That illuminates roads excellently. Following a natural principle: vision is best during the day. With a colour temperature similar to daylight, the light from Audi LED headlights helps to reduce eye fatigue. Route data is used to adjust the light distribution to the respective situation. In advance. Thanks to being networked with MMI navigation plus. So you see as much as possible – and your Audi catches the eye.



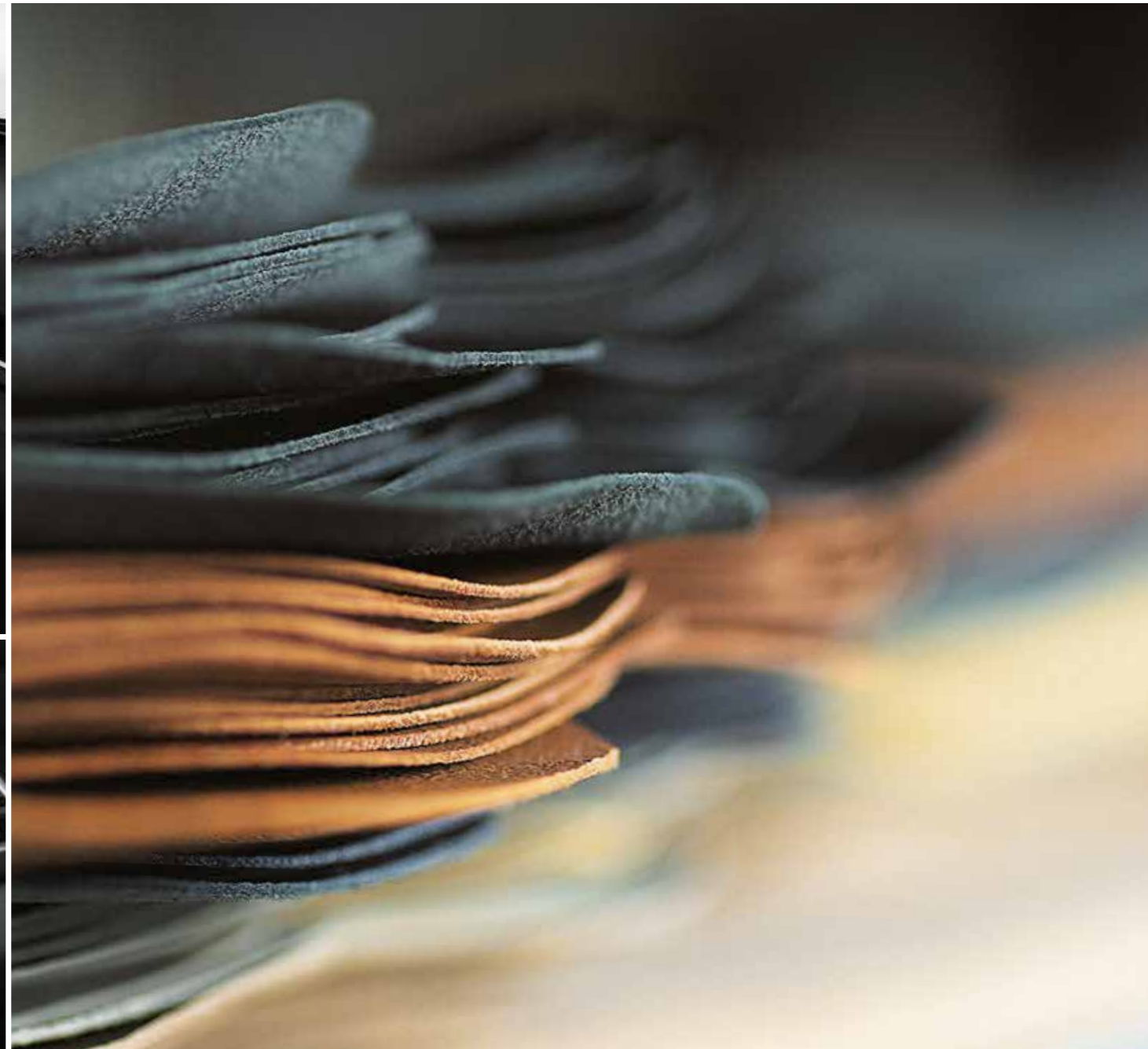

As unique as you are. The equipment options.

Sportiness, comfort, design, functionality – whatever you demand of your Audi, it offers you a wealth of custom options. Audi equipment versions are varied and high-quality and you can tailor them entirely to your needs.

Character takes on many forms. Here are two of them.

What makes an Audi your Audi? Vehicle equipment entirely tailored to your needs. There are a wide range of options available to you for giving your vehicle the exact touch you have in mind. More sportiness? More elegance? Let yourself be inspired.

Audi Q3 in Misano red, pearl effect

Cast aluminium wheels in 5-parallel-spoke design

Sport seats in sprint cloth/leather, black

Inlays in matt brushed aluminium

S line multifunction sport leather steering wheel in 3-spoke design



Audi Q3 in monsoon grey, metallic

Audi Sport cast aluminium wheels
in 5-twin-spoke offroad design^{1,2}

Audi exclusive design exterior package²

Sport seats in fine Nappa leather in Chennai brown with
contrasting stitching in granite grey^{1,2}

Inlays in 3D aluminium mesh, silver^{1,2}



The fuel consumption and CO₂ emission figures can be found from page 88 onwards.

¹Part of Audi exclusive design package. ²From quattro GmbH.

There's a sign for maximum efficiency at Audi.
The Audi Q3 ultra models – the most sustainable TFSI® and TDI® models in the range.

Technologies and measures for reducing consumption and emission without any reduction in driving enjoyment – that's what Audi ultra stands for. Standard in every Audi model. The long-term aim: completely emission-free mobility. To achieve this, we are systematically continuing our development work. On more and more efficient drive technologies, for example. Such as the economical petrol or diesel engines. We award the most sustainable of these with the ultra emblem on the rear of the model, which announces: maximum efficiency ahead. Thanks to combined CO₂ emission values of 114 g/km for the Audi Q3 2.0 TDI ultra model and from 127 g/km for the 1.4 TFSI ultra model. And without having to give up the dynamics typical of Audi. Experience the Audi Q3 ultra models – vehicles that redefine efficient driving.

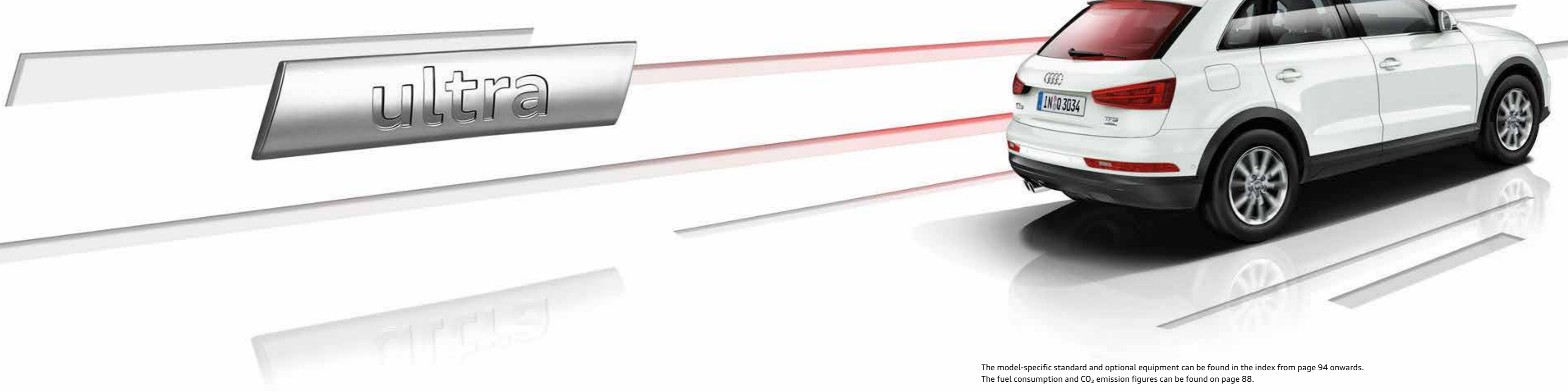

The **1.4 litre TFSI ultra engine** with 110 kW and Audi cylinder on demand technology has the following CO₂ emission value in the combined driving cycle: from 127 g/km.

The **2.0 litre TDI ultra engine** with 110 kW has the following CO₂ emission value in the combined driving cycle: 114 g/km.

The model-specific standard and optional equipment can be found in the index from page 94 onwards.
The fuel consumption and CO₂ emission figures can be found on page 88.

The right driving force for every personality.

No matter which Audi engine you choose, they all have high compression ratios, highly efficient combustion and outstanding efficiency. In short, they deliver more power whilst using less fuel and producing fewer emissions.



1.4 TFSI



2.0 TDI

TFSI®

The Audi TFSI engines offer outstanding efficiency and improved performance whilst at the same time retaining their dynamism. For example the 1.4 TFSI ultra 110 kW with Audi cylinder on demand technology in the Audi Q3, enabling the car to accelerate from 0 to 100 km/h in 9.2 seconds and reach a top speed of 204 km/h.

- 1.4 TFSI ultra (110 kW) with Audi cylinder on demand technology
- 1.4 TFSI (110 kW) with Audi cylinder on demand technology
- 1.4 TFSI (110 kW)
- 2.0 TFSI (132 kW)*
- 2.0 TFSI quattro (162 kW)

TDI®

Audi TDI engines: high torque output over the entire engine speed range – with constant power build-up. They are renowned for being fuel-efficient and for reducing emissions. The 2.0 TDI, for example, has a power output of 110 kW, a top speed of 204 km/h and accelerates from 0 to 100 km/h in 9.6 seconds.

- 2.0 TDI (88 kW)
- 2.0 TDI ultra (110 kW)
- 2.0 TDI (110 kW)*
- 2.0 TDI (135 kW)*

The fuel consumption and CO₂ emission figures can be found from page 88 onwards. *Also available with quattro permanent all-wheel drive.

From sportiness to luxury. The choice is yours.

You can shape your Audi Q3 entirely according to your wishes with a variety of different equipment lines. Give it a sporty look or highlight the design even more. You can choose different nuances. It is all up to you. Whatever you decide on – each of the following equipment options turns driving an Audi into a special experience.



Q3

Introduction to customising your vehicle. The Audi Q3 offers you attractive equipment ranges giving your vehicle its own character. On the exterior and interior alike. And of course, with all our products you can rely on the proverbial Audi quality.

Model-specific standard equipment

Exterior distinguishing features:

Forged aluminium wheels in 7-arm design, size 6.5 J x 16 with 215/65 R 16 tyres*

Roof rails, trim strips and loading sill protector in black

Interior distinguishing features:

Inlays in micrometallic, silver, for door trims and dashboard

Door sill trims in plastic

Seat upholstery in initial cloth

Functional distinguishing features:

Standard seats, front

Steering wheel in 4-spoke design



The model-specific standard and optional equipment can be found in the index from page 94 onwards.

The fuel consumption and CO₂ emission figures can be found from page 88 onwards. *You will find specifications on the technical characteristics of tyres on page 92.

Emphasise the sporty character even more – the sport ranges for your Audi Q3.



Q3 sport

Show yourself from your sporty side – all along the line. With details that emphasise the temperament of your Audi Q3 in impressive style. On the exterior with measures that indicate powerful performance at first sight. And in the interior with accessories that impart a touch of sports car atmosphere.

Model-specific standard equipment

Exterior distinguishing features:

Cast aluminium wheels in 5-spoke Y design, size 7 J x 17 with 235/55 R 17 tyres*

Full paint finish

Gloss package

Roof rails in anodised aluminium

Interior distinguishing features:

Inlays in micrometallic, silver, for door trims and dashboard

Seat upholstery in sport cloth

Aluminium-look interior

Functional distinguishing features:

Sport seats, front

4-way lumbar support for the front seats

Leather steering wheel in 3-spoke Q design

Driver information system

Audi drive select



**As unmistakable as your own standards –
the design ranges for your Audi Q3.**



Q3 design

An Audi is the result of the interaction of many high-quality details that have been thought out from the very outset. At the same time, it offers enough room to include and realise your own ideas. The Q3 design line allows you to give your Audi Q3 striking accents which reflect your personality individually.

Model-specific standard equipment

Exterior distinguishing features:

Cast aluminium wheels in 5-V-spoke design, size 7 J x 17 with 235/55 R 17 tyres*

Contrasting paint finish

Gloss package

Roof rails in anodised aluminium

Loading sill protector in stainless steel

Interior distinguishing features:

Inlays in aluminium tangent, silver or bronze for door trims and dashboard

Door sill trims with aluminium inlays

Seat upholstery in style cloth

Aluminium-look interior

Functional distinguishing features:

Standard seats, front

4-way lumbar support for the front seats

Leather steering wheel in 4-spoke design

Driver information system

Audi drive select



Remaining faithful to the sporty line: the S line packages.



The S line packages emphasise the sporty character of your Audi Q3. Accentuate the dynamic body line, lend the interior even more expression or give the suspension even sportier definition for enhanced driving dynamics. And make a true athlete of your Audi.

S line exterior package

Front and rear bumpers and diffuser insert
in a striking, sporty design

Bumper, door trim strips and wheel arch trims
painted in body colour

Insert in rear bumper
in honeycomb design

Radiator grille
in gloss black

Door sill trims with aluminium inlays
with S line logo

Loading sill protector in stainless steel

S line emblem
on the front wings



S line sport package

The following range of equipment is included in the S line sport package:

Cast aluminium wheels in 5-parallel-spoke design (S design)
size 7 J x 18 with 235/50 R 18 tyres¹

S line sport suspension
dynamic suspension tuning and vehicle lowered by 20 mm

Door sill trims with aluminium inlays
with S line logo

Loading sill protector in stainless steel

S line emblem
on the front wings

Interior, dashboard and headlining
in black with contrasting stitching on seat upholstery, steering wheel, gear lever knob or selector lever gaiter (with sprint cloth/leather or perforated Alcantara/leather)

Sport seats, front
including electric 4-way lumbar support

S line seat upholstery with sprint cloth/leather, black
with S line embossing on the front-seat backrests

S line sport leather steering wheel in 3-spoke design
in black leather (steering wheel grips in perforated leather) with S line emblem

Gear or selector lever knob
in perforated leather

S line inlays
matt brushed aluminium

Optionally available:

Further wheels in size 18 inch or larger illustrated here: Audi Sport cast aluminium wheels in 5-V-spoke design in matt titanium look, gloss turned finish^{2, 3}
size 8.5 J x 20 with 255/35 R 20 tyres¹

S line seat upholstery in perforated Alcantara/leather or fine Nappa leather
each in black or for fine Nappa leather additionally in rotor grey with S line embossing in the front-seat backrests

S line multifunction sport leather steering wheel in 3-spoke design
in black leather (steering wheel grips in perforated leather) with S line emblem; models with automatic transmission optionally have shift paddles behind the steering wheel

S line multifunction sport leather steering wheel in 3-spoke design, flattened at the bottom⁴
models with automatic transmission optionally have shift paddles behind the steering wheel

Inlays
Piano finish, black³

Paint finish in all standard/optional equipment colours and additionally in the special colour of Daytona grey, pearl effect

¹You will find specifications on the technical characteristics of tyres on page 92. ²Please note the special information relating to wheels on page 91. ³From quattro GmbH. ⁴For information on when this feature will be available, please contact your Audi partner.

**No matter where your destination is.
Remain faithful to your line.**



Audi exclusive design exterior package¹

Do you always go your own way? You can express that attitude when driving your Audi Q3 by means of the Audi exclusive design exterior package. Whether in the city, on the motorway or on a country road – a selection of striking details emphasises the offroad character of your vehicle and accentuates its succinct body line. For a powerful yet elegant appearance.

The Audi exclusive design exterior package¹ includes the following equipment ranges:

Front and rear bumpers
in striking design, contrasting area painted in matt stone grey

Underbody protection
on front and rear bumpers painted in matt Barceloneta silver

Door trim strips in separate design and wheel arch trims
painted in matt stone grey

Loading sill protector in stainless steel

Door sill trims with Audi exclusive logo



Audi exclusive design package¹

Cast aluminium wheels in 5-arm turbine design
partly polished², size 7 J x 18 with 235/50 R 18 tyres³

Door sill trims with Audi exclusive logo

Door trim inserts and headlining in black

Sport seats, front, in cloth/leather combination

Seat side bolsters, centre armrest, front (if ordered) and head restraints
in pearl Nappa leather in Chennai brown with contrasting stitching in granite grey

Seat centre panels
in Norit cloth, sport stripes in single-colour rallye cloth

Multifunction leather steering wheel in 4-spoke design
and gear lever knob or selector lever knob and gaiter in black with contrasting stitching in Chennai brown

Floor mats in black with nubuck piping in Chennai brown

3D aluminium mesh inlays, silver

Suspension with comfortable tuning

Optionally available:

Sport seats and centre armrest, front (if ordered) in fine Nappa leather in Chennai brown with contrasting stitching in granite grey

or:

Sport seats and centre armrest, front (if ordered) in fine Nappa leather in black with contrasting stitching in Chennai brown

Multifunction sport leather steering wheel in 3-spoke Q design, optionally with shift paddles, black with contrasting stitching in Chennai brown

Inlays in piano finish, black or walnut, balsamic brown



You have an exclusive character. So why shouldn't your Audi have one too?

That the Audi exclusive range aspires to exclusivity is already evident from its name. Selected décors and coloured leather can be combined with customised paint finishes from the large selection of Audi exclusive colours to suit your own personal preferences. So you can highlight your car's exceptional character to even better advantage. Your Audi partner and the Audi exclusive Studio of the Audi Forum Neckarsulm await your wishes.



If you want to find out more about the Audi exclusive equipment versions and quality standards, just scan this QR code using your smartphone. Or follow this link in your browser:
www.audi.com/exclusivefilm



Audi Q3 with Audi exclusive customised paint finish in speed yellow and Audi exclusive black gloss package

Audi Sport cast aluminium wheels in 5-V-spoke design in matt titanium look, gloss turned finish*

Leather upholstery and trim in Audi exclusive fine Nappa leather with sport seats, front, in black with inserts in the front seats and head restraints, as well as contrasting stitching in calendula yellow

Audi exclusive leather controls in black with contrasting stitching in calendula yellow

Door trim inserts in fine Nappa leather, black

Inlays in piano finish, black

Audi exclusive floor mats in black with leather piping and seam in calendula yellow



Your Audi is painted not just once. But four times.

When you choose a paint colour, choose one that best reflects your own personality. But whichever colour you opt for, you can count on the outstanding quality of our painting process. Though no thicker than a human hair, the layer of paint on an Audi is actually made up of four different coats. So not only do you look radiant in your Audi, the car is also optimally protected from environmental influences and wear. For its entire lifetime.



| Pearl effect paint finishes



Daytona grey, pearl effect

| Contrasting paint finish



Anthracite, matt

| Customised paint finishes



Audi exclusive customised paint finishes
From quattro GmbH



Misano red, pearl effect

Metallic/pearl effect paint finishes

Front and rear bottom bumper section, underbody protection as well as door trim strips and wheel arch trims in black non-painted grained (choice of contrasting or full paint finish).

Contrasting paint finish

Front and rear bumpers, as well as wheel arch trims and door trim strips painted in matt anthracite; front spoiler lip, door inlay and underbody protection, rear painted in matt Barceloneta silver

Full paint finish

Front and rear bottom bumper section as well as door trim strips, wheel arch trims and underbody protection, front painted in body colour, underbody protection, rear painted in matt anthracite

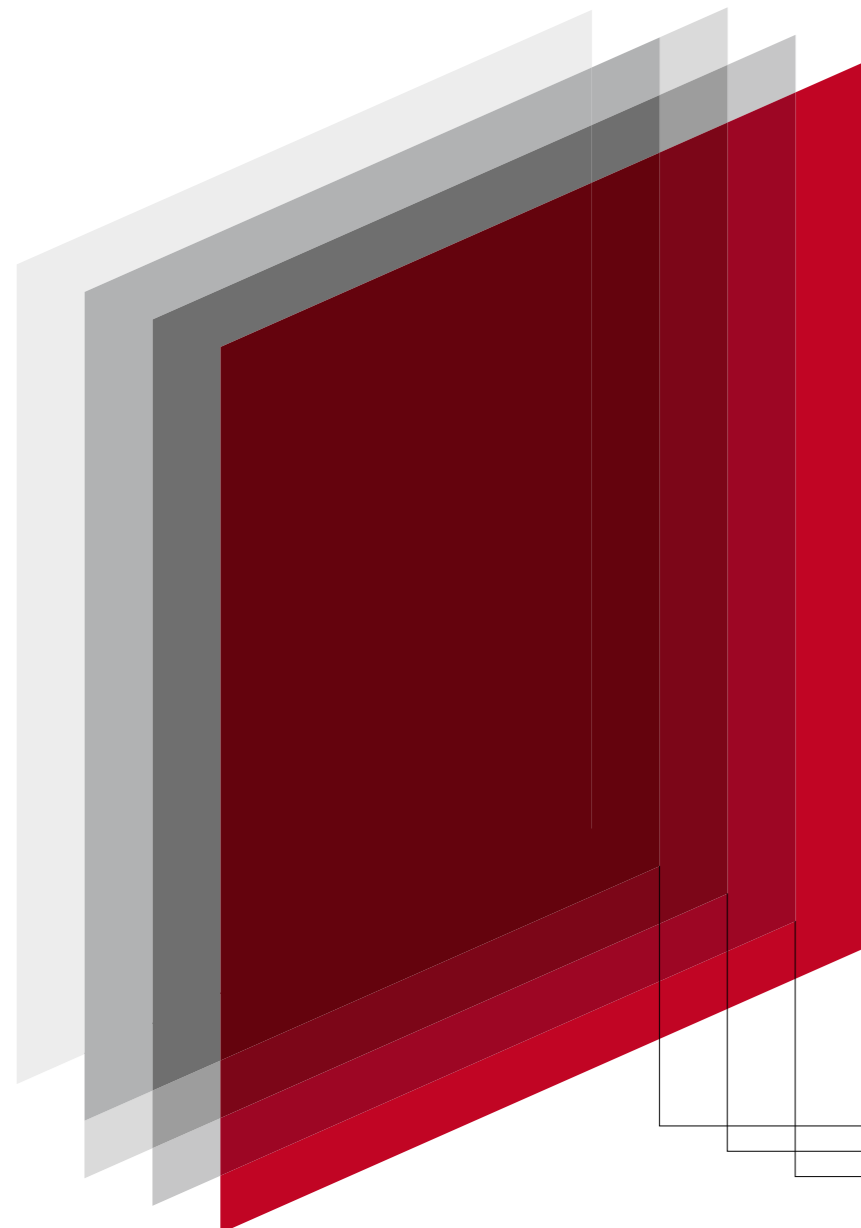

In our view, millimetre precision is simply not enough to ensure you will still be able to enjoy your favourite colour for your Audi even after driving many thousands of kilometres. That is why we deliver precision on the micrometre scale, and why it takes top priority even for the primer coat. The first layer protects the body from rust and other symptoms of old age. The filler layer compensates for even the tiniest of irregularities and has an elastic effect, stopping the paint flaking off if for example gravel is thrown up. The third layer is the visible colour. Then comes a fourth layer of clear varnish, which protects the paint finish from UV rays and gives it a sheen and depth of colour that will ideally last for a long time – until you decide on a new favourite colour.

- Primer coat
- Filler layer
- Coloured paint
- Clear varnish

| Solid paint finishes



Cortina white

| Metallic paint finishes



Glacier white, metallic

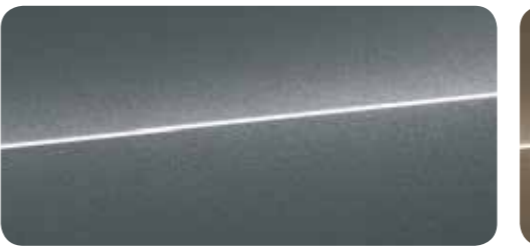

Monsoon grey, metallic

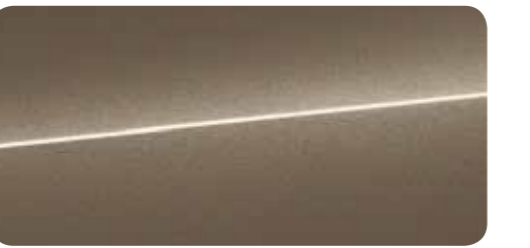

Tundra brown, metallic

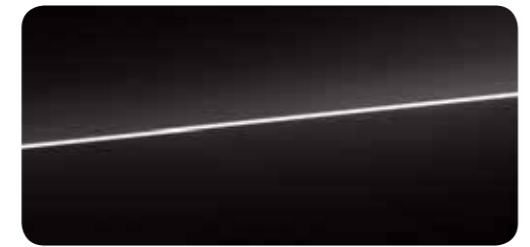

Brilliant black

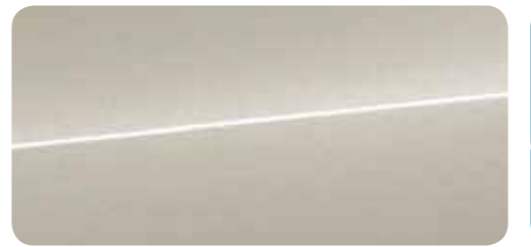

Cuvée silver, metallic



Hainan blue, metallic

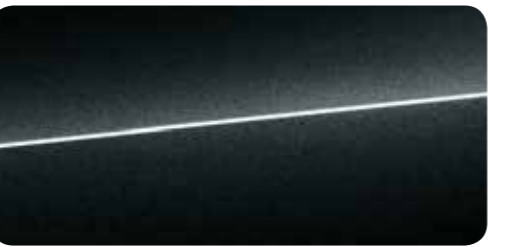

Mythos black, metallic



Floret silver, metallic

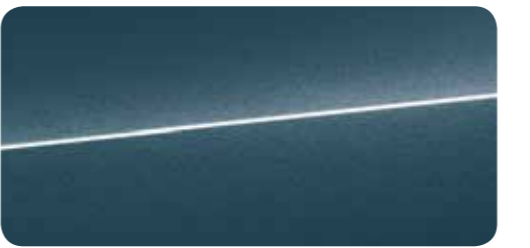

Utopia blue, metallic

| Pearl effect paint finishes

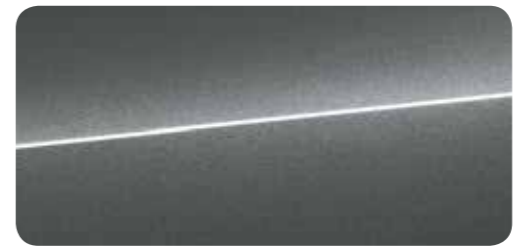

Daytona grey, pearl effect

| Contrasting paint finish



Anthracite, matt

| Customised paint finishes



Audi exclusive customised paint finishes
From quattro GmbH



Misano red, pearl effect

Metallic/pearl effect paint finishes
Front and rear bottom bumper section, underbody protection as well as door trim strips and wheel arch trims in black non-painted grained (choice of contrasting or full paint finish).

Contrasting paint finish
Front and rear bumpers, as well as wheel arch trims and door trim strips painted in matt anthracite; front spoiler lip, door inlay and underbody protection, rear painted in matt Barceloneta silver

Full paint finish
Front and rear bottom bumper section as well as door trim strips, wheel arch trims and underbody protection, front painted in body colour, underbody protection, rear painted in matt anthracite



Quality given form. And a brilliant finish. Audi wheels.

To make sure you have peace of mind for every metre of your drive, Audi puts its wheels through an exacting series of specialised test procedures. Hardness tests, for example, aim for maximum stability, while a copper accelerated salt spray test – CASS for short – using acetic acid guarantees the greatest possible corrosion protection. Thanks to these and many other measures, we can ensure that every Audi wheel offers maximum quality – even after scores of kilometres. No matter which of the numerous designs you choose.

| Winter wheels



Audi Sport cast aluminium wheels in 5-twin-spoke offroad design
size 8.5 J x 19 with 255/40 R 19 tyres¹.
From quattro GmbH



Audi Sport cast aluminium wheels in 5-arm rotor design in matt titanium look, gloss turned finish²
size 8.5 J x 20 with 255/35 R 20 tyres¹.
From quattro GmbH



Forged aluminium winter wheels in 7-arm design
size 6.5 J x 16 with 215/65 R 16 tyres¹,
can be fitted with snow chains,
permissible top speed 210 km/h



Audi Sport cast aluminium wheels in 5-segment-spoke design
size 8.5 J x 19 with 255/40 R 19 tyres¹.
From quattro GmbH



Audi Sport cast aluminium wheels in 5-V-spoke design in matt titanium look, gloss turned finish²
size 8.5 J x 20 with 255/35 R 20 tyres¹.
From quattro GmbH



Cast aluminium winter wheels in 5-arm Trias design
size 6.5 J x 17 with 215/60 R 17 tyres¹,
can be fitted with snow chains,
permissible top speed 210 km/h



Audi Sport cast aluminium wheels in 10-spoke design in matt titanium look, gloss turned finish²
size 8.5 J x 19 with 255/40 R 19 tyres¹.
From quattro GmbH

All-season tyres
Tyres for use all year round, size 235/55 R 17¹

¹You will find specifications on the technical characteristics of tyres on page 92. ²Please note the special information relating to wheels on page 91.



The perfect connection between an Audi and the road.

With a wide variety of designs and top-quality workmanship, we have a comprehensive range of wheels to put the perfect finishing touch to your Audi. Each Audi model has a tailored set of wheel options. Emphasise the character of your Audi according to your own individual wishes. Would you perhaps like to give it a more dynamic appearance? Then our special Audi Sport range of wheels is what you're looking for. Just let yourself be inspired. No matter which design you choose, it is you who determines the style.

| Summer wheels



Forged aluminium wheels in 7-arm design
size 6.5 J x 16 with 215/65 R 16 tyres¹



Cast aluminium wheels in 5-V-spoke design
size 7 J x 17 with 235/55 R 17 tyres¹



Audi Sport cast aluminium wheels in 5-twin-spoke design
size 7 J x 18 with 235/50 R 18 tyres¹.
From quattro GmbH



Cast aluminium wheels in 5-arm turbine design, partly polished²
size 7 J x 18 with 235/50 R 18 tyres¹



Cast aluminium wheels in 5-arm Trias design
size 7 J x 17 with 235/55 R 17 tyres¹



Cast aluminium wheels in 5-spoke Y design
size 7 J x 17 with 235/55 R 17 tyres¹



Audi Sport cast aluminium wheels in 5-arm structured design
size 8 J x 18 with 235/50 R 18 tyres¹.
From quattro GmbH



Cast aluminium wheels in 5-arm turbine design, contrasting grey, partly polished²
size 7 J x 18 with 235/50 R 18 tyres¹



Cast aluminium wheels in 10-spoke design
size 7 J x 17 with 235/55 R 17 tyres¹



Audi Sport cast aluminium wheels in 5-arm offroad design
size 7 J x 18 with 235/50 R 18 tyres¹.
From quattro GmbH



Cast aluminium wheels in 5-spoke dynamic design
size 7 J x 18 with 235/50 R 18 tyres¹



Cast aluminium wheels in 5-parallel-spoke design (S design)
size 7 J x 18 with 235/50 R 18 tyres¹

| Winter wheels



Audi Sport cast aluminium wheels in 5-twin-spoke offroad design
size 8.5 J x 19 with 255/40 R 19 tyres¹.
From quattro GmbH



Audi Sport cast aluminium wheels in 5-arm rotor design in matt titanium look, gloss turned finish²
size 8.5 J x 20 with 255/35 R 20 tyres¹.
From quattro GmbH



Forged aluminium winter wheels in 7-arm design
size 6.5 J x 16 with 215/65 R 16 tyres¹,
can be fitted with snow chains,
permissible top speed 210 km/h



Audi Sport cast aluminium wheels in 5-segment-spoke design
size 8.5 J x 19 with 255/40 R 19 tyres¹.
From quattro GmbH



Audi Sport cast aluminium wheels in 5-V-spoke design in matt titanium look, gloss turned finish²
size 8.5 J x 20 with 255/35 R 20 tyres¹.
From quattro GmbH



Cast aluminium winter wheels in 5-arm Trias design
size 6.5 J x 17 with 215/60 R 17 tyres¹,
can be fitted with snow chains,
permissible top speed 210 km/h



Audi Sport cast aluminium wheels in 10-spoke design in matt titanium look, gloss turned finish²
size 8.5 J x 19 with 255/40 R 19 tyres¹.
From quattro GmbH

All-season tyres
Tyres for use all year round, size 235/55 R 17¹

¹The model-specific standard and optional equipment can be found in the index from page 94 onwards.

²You will find specifications on the technical characteristics of tyres on page 92. ³Please note the special information relating to wheels on page 91.

Premium quality you can rely on.

You have a special place in your Audi. Exclusive comfort can be felt on the front and rear seats: thanks to high-quality materials and first-class workmanship. Whether you decide on standard seats with cloth or leather upholstery or sport seats with stable lateral support for dynamic driving: you're sitting in the right place.



manual adjustment of head restraint height

manual adjustment of the seat belt height

manual adjustment of the backrest angle

manual adjustment of the seat height

manual adjustment of the fore/aft position

storage compartment under the right front seat (optional)



shaped seat side bolsters

4-way lumbar support for the front seats (optional)

adjustment of the seat angle

extendable thigh support

Standard seats, front 1

The illustration shows standard seat, front, in initial cloth, black.

Sport seats, front 2

The illustration shows sport seat, front, electrically adjustable in fine Nappa leather, Chennai brown.

| Cloth



Initial cloth, black

| Cloth/leather



1 Sprint cloth/leather, black with contrasting stitching

| Leather/artificial leather



2 Leather/artificial leather, black

| Alcantara/leather



1 Alcantara/leather, black

2

| Leather



Milano leather, black

1 2



Fine Nappa leather, pistachio beige

| Audi exclusive design package

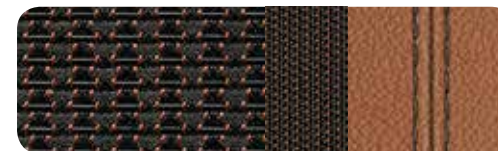

1 Norit cloth/rallye cloth in single-colour/pearl Nappa leather, Chennai brown with contrasting stitching in granite grey*

| Audi exclusive



2 Audi exclusive leather upholstery and trim* Individual choice of colour for leather/stitching

1 2



Style cloth, black

1



Leather/artificial leather, chestnut brown

1



Alcantara/leather, rock grey

2



Fine Nappa leather, black

1 2



Fine Nappa leather, rotor grey with contrasting stitching

2



Fine Nappa leather, Chennai brown with contrasting stitching in granite grey*

2



Style cloth, rock grey

1



Leather/artificial leather, rock grey

1



1 Perforated Alcantara/leather, black with contrasting stitching

2



Fine Nappa leather, black with contrasting stitching

2



Fine Nappa leather, black with contrasting stitching in Chennai brown*

2



Sport cloth, black

2



Leather/artificial leather, pistachio beige

1



Fine Nappa leather, chestnut brown

1 2



Fine Nappa leather, rock grey

1

| Seat options

1 Standard seats, front

2 Sport seats, front



Fixedated on quality.

With Audi seats, you can rely not only on elegant materials and top-class workmanship, but on comprehensive testing procedures as well. Audi tests the quality of all seat leather in its own laboratory, for instance. 45 tests are used to determine the durability alone. Clamped in automatic jigs, the leather samples have to show how evenly they stretch, where they start to tear and when they start to develop folds, how abrasion proof and flame resistant they are. Only leather that passes all the tests with flying colours is used for Audi seats.

| Cloth and leather upholstery and trim

Initial or style cloth upholstery and trim

For standard seats, front: seat centre panels in initial or style cloth and seat side bolsters, head restraints, door trim inserts and centre armrest, front (if ordered) in single-colour cloth

Sport cloth upholstery and trim

For sport seats, front: seat centre panels in sport cloth and seat side bolsters, head restraints, door trim inserts and centre armrest, front (if ordered) in single-colour cloth

Alcantara/leather combination

Exclusive, sporty look for sport seats; high seating comfort and a good seating climate thanks to rapid temperature equalisation; particularly hard-wearing, easy to clean and resistant to wear and tear. The Alcantara seat centre panels provide good support, making it especially suitable for dynamic driving styles. The seat side bolsters made from the finest leather complete the seat.

For sport seats, front: seat centre panels and door trim inserts in Alcantara and seat side bolsters and centre armrest, front (if ordered) in leather

Milano leather upholstery and trim

Extremely hard-wearing and durable leather that gives a high-quality impression with its fine, grained surface. Fully penetrated with dye and tanned without the use of chromium, the leather provides outstanding surface protection thanks to the paint finish.

For standard and sport seats, front: seat centre panels, seat side bolsters, head restraint centre panels and centre armrest, front (if ordered) in Milano leather, door trim inserts in artificial leather

| Leather package

Fine Nappa leather upholstery and trim

high-quality, supple leather with a balanced lacquer coat. It has air-permeable properties thanks to its natural surface, thereby contributing to a pleasant seating climate. The leather is extremely hard-wearing, durable and resistant to fading. Its fine embossing underlines its exclusive character.

For standard and sport seats, front: seat centre panels, seat side bolsters, head restraint centre panels in fine Nappa leather, centre armrest, front (if ordered) in leather, door trim inserts in artificial leather

Leather/artificial leather combination

For standard seats, front: seat centre panels of front seats and both outer rear seats, as well as outer bolster on the driver side in leather; seat side bolsters, centre rear seat, head restraints, door trim inserts and centre armrest, front (if ordered) in artificial leather

| Leather package

Audi exclusive fine Nappa leather upholstery and trim*

Seat centre panels, seat side bolsters, head restraints and centre armrest, front (if ordered) in fine Nappa leather, colour-coordinated door trim inserts; floor mats, black with coloured leather piping. Individual choice of colour for the leather and the stitching from the range of Audi exclusive colours.

| Seat comfort

Driver seat, electrically adjustable

with electrical adjustment of the seat height, fore/aft position, seat angle and backrest angle; front-passenger seat manually adjustable

Front seats, electrically adjustable

same functions as driver seat, electrically adjustable, additionally also for front-passenger seat

Seat heating, front

heats the seat and backrest centre panels, in case of leather upholstery and trim and sport seats also heats the seat side bolsters; separately adjustable in several stages for driver and front-passenger side

Centre armrest, front

adjustable angle and can be adjusted lengthways, with fold-open storage compartment and a 12V socket in the rear centre console

| Seats in the rear

Rear seat backrest, folding

can be split-folded 40:60 or fully collapsed

| Headlinings

Headlining in cloth

to match the interior colour, in lunar silver or pistachio beige; with the interior colour Chennai brown, the headlining is black

Headlining in cloth, black

| Leather



Milano leather, black

1 2

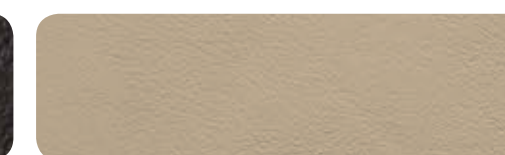

Fine Nappa leather, pistachio beige

1



Fine Nappa leather, black

1 2



Fine Nappa leather, rotor grey

2

with contrasting stitching



Fine Nappa leather, black

2

with contrasting stitching



Fine Nappa leather, chestnut brown

1 2



Fine Nappa leather, rock grey

1

| Audi exclusive design package



Norit cloth/rallye cloth in single-colour/pearl Nappa leather, Chennai brown with contrasting stitching in granite grey*

2



Fine Nappa leather, Chennai brown

2

with contrasting stitching in granite grey*



Fine Nappa leather, black

2

with contrasting stitching in Chennai brown*

| Audi exclusive



Audi exclusive leather upholstery and trim*

1 2

Individual choice of colour for leather/stitching

| Seat options

1 Standard seats, front

2 Sport seats, front

*From quattro GmbH.

The model-specific standard and optional equipment can be found in the index from page 94 onwards.

Experience fascination. Down to the last detail.

Exclusive ambience is a question of style. Your style. A style you can refine right down to the last detail. Create tangible accents with high-quality Audi inlays. Take pleasure in smooth wood that radiates a natural warmth. Experience the fascination of open-pore wood whose exclusivity you can literally feel. Or make a personal statement with combinations of fine woods and aluminium trim – and allow your own personal taste to determine the character.



The model-specific standard and optional equipment can be found in the index from page 94 onwards.



Micrometallic, silver



Aluminium satellite



Walnut, balsamic brown

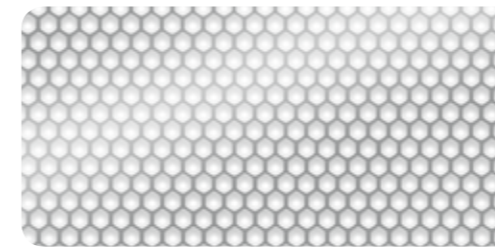

3D aluminium mesh, silver



Aluminium tangent, silver



Piano finish, black*



Matt brushed aluminium



Aluminium tangent, bronze



Inlays in Audi exclusive wood*

Inlays

for the dashboard, door trims and centre console

Inlays in aluminium or wood

Items as inlays, additionally aluminium-look interior at air vents, gear lever knob or selector lever gaiter, light switch, 12V socket, window control switches and mirror adjustment switch; bottom edge of air vents in gloss black

Inlays in Audi exclusive wood*

available in fine grain ash, nougat, oak sepia, fine grain myrtle, nutmeg, vavona bronze, modrone gold or tamo ash, natural dark brown.

*From quattro GmbH.

| **Headlights****Xenon plus**

intensive road illumination, good uniformity and range thanks to headlights with durable gas discharge technology for dipped and high beam. Automatic dynamic headlight range control that prevents oncoming traffic from being dazzled. Including homogeneous LED daytime running light strip and all-weather light

**LED headlights**

allow precise, near daylight illumination of the road and combine dipped beam, high beam, daytime running lights, motorway light, indicator and static turning light as well as all-weather light function in LED technology; including headlight cleaning system; motorway light with automatically increased headlight range from a speed of approximately 110 km/h; all-weather light function to reduce the risk of the driver being dazzled when visibility is poor; striking light pattern in day and night design including homogeneous daytime running light strip and integrated LED indicator; with low power consumption and long service life

High-beam assist

improves the driver's visibility and ensures a more relaxed drive thanks to the extra comfort and convenience. Depending on the traffic situation, the high beam is automatically switched on or off. Working within system limits, it automatically detects the headlights of oncoming traffic, the rear lights of other road users and light sources from built-up areas.

Headlight cleaning system

for excellent illumination and improved visibility thanks to reduced scatter; works with water and high pressure

Light/rain sensor

automatic control of lights-on function, windscreen wipers and coming home/leaving home function: delayed switching-off/automatic switching-on of the main headlights, the rear lights and the number plate lights when parking/opening the vehicle; including acoustic windscreen with grey strip along the top edge

**Rear lights**

with reversing lights and rear fog lights; -including third brake light, high-mounted in rear window and LED rear number plate lights

**LED rear lights**

brake lights, tail lights, indicators and rear number plate lights in LED technology with low power consumption; with reversing lights, 2 rear fog lights and third brake light, high-mounted in rear window

**LED rear lights with dynamic indicator**

in addition to the functions of the LED rear lights, a dynamic and clearly visible indicator curve is generated: segments of LED arrays are triggered for a few milliseconds, creating a pulse of light that runs outwards in the direction in which the car is turning. When operated, the indicators send a distinctive signal to other road users

| **Interior lighting****LED interior lighting package**

anti-glare lighting of vehicle interior in energy-saving and long-lasting LED technology, comprising:

- interior lighting front and rear, including reading lights
- reflected lighting for centre console and inside of the door
- vanity mirror lights for driver and front passenger
- illuminated cup holders
- illuminated storage compartment in the centre console
- door sill and footwell light, front as well as lighted door openers
- illuminated vent controls
- active door reflectors (light bulbs)

Interior lighting

front and rear; with delayed switch-off and contact switches on all doors; glove compartment and luggage compartment lighting

| **Exterior design****Audi Singleframe**

one-piece trim frame around radiator grille in stone grey; in 3D-design

Model name/logo

Q3 logo, ultra emblem (for the Q3 1.4 TFSI ultra 110 kW, Q3 2.0 TDI ultra 110 kW) and TDI or TFSI logo on the luggage compartment lid, can each be omitted on request

Roof rails

in anodised aluminium or black; for transportation of items, sturdy and aerodynamically shaped

| Interior design

**Exhaust tailpipes**

single-branch design with 2 tailpipes; on the 2.0 TFSI (162 kW) 1 tailpipe each left and right; with chromed trim

Gloss package

roof frame and window slot trim in anodised aluminium, exterior B- and C-pillar trim in gloss black

Audi exclusive black gloss package¹

creates black styling accents around the Audi Singleframe, the front bumper and trim strips on the side windows. The design varies depending on the selected equipment

**Door sill trims and loading sill protector**

door sill trims with aluminium insert and loading sill protector in stainless steel

Door sill trims in plastic**Aluminium-look interior**

elements in aluminium look at light switch, mirror adjustment switch, window control switches, air vents, 12V socket and around the gear lever knob or selector lever gaiter; bottom edge of air vents in gloss black

| Steering wheels/controls

**Multifunction leather steering wheel in 4-spoke design**

for operating the available infotainment features; adjustable in height and reach, with full-size airbag; colour-coordinated with the selected colour for the top side of the dashboard; with optional shift paddles for changing gears manually with automatic transmission

Leather steering wheel in 4-spoke design

adjustable in height and reach, with full-size airbag; colour-coordinated with the selected colour for the top side of the dashboard

**Multifunction sport leather steering wheel in 3-spoke Q design**

for operating the available infotainment features; adjustable in height and reach, with full-size airbag; colour-coordinated with the selected colour for the top side of the dashboard; with optional shift paddles for changing gears manually with automatic transmission

**Multifunction sport leather steering wheel in 3-spoke design, flattened at the bottom²**

for operating the available infotainment features; adjustable in height and reach, with full-size airbag; colour-coordinated with the selected colour for the top side of the dashboard; with optional shift paddles for changing gears manually with automatic transmission

**Sport leather steering wheel in 3-spoke Q design**

adjustable in height and reach, with full-size airbag; colour-coordinated with the selected colour for the top side of the dashboard

Audi exclusive aluminium gear lever knob¹**Audi exclusive leather controls¹**

Leather-covered steering wheel rim, gear lever knob or selector lever knob and gaiter in Audi exclusive leather. Individual choice of colour for the leather and the stitching from the range of Audi exclusive colours. Stitching on the steering wheel rim with specific Audi exclusive seam detail

| Mirrors

**Exterior mirrors with integrated LED indicator**

electrically adjustable, aspherical mirror glass on the left, convex on the right; body-coloured housing

also optionally:

heated

including heated windscreen washer jets

heated and electrically folding

including heated windscreen washer jets and automatic kerb-side function for the exterior mirror on the passenger side

heated, electrically folding and automatically dimming on the driver side

including heated windscreen washer jets and automatic kerb-side function for the exterior mirror on the passenger side

The automatic kerb-side function tilts the exterior mirror on the passenger side downwards when reverse gear is selected, giving the driver a better view of the kerb.

Interior mirror**manually dimming**

or optionally:

automatically dimming

with light/rain sensor, windscreen with grey strip and acoustic glazing

| Roof system

**Panoramic glass sunroof**

in 2 sections, electrical activation to raise and open the front glass section; with tinted glass insert and electrically operated sun blind, as well as convenience closing/opening from the outside via the vehicle key; ensures an interior that is flooded with light, improves the interior climate by means of efficient ventilation; including integrated wind deflector

| Glazing

**Dark-tinted windows (privacy glazing)**

dark-tinted rear window and rear door windows and rear side windows

Acoustic windscreen

heat-insulating glass with improved acoustic windscreen insulation, with grey strip

| Climate control



Deluxe automatic air conditioning

- electronically controls the air temperature, flow rate and distribution
- separate temperature control for driver and front-passenger seat
- separate defroster button for faster defrosting of front and side windows
- automatic recirculation mode by means of air quality sensor
- sunlight-dependent control
- combined filter
- light/rain/humidity sensor
- air vents in the centre console, rear
- ventilated glove compartment
- key-coded settings

Manual air conditioning

- cools or heats up the vehicle passenger compartment
- separate defroster button for faster defrosting of front and side windows
- manually regulated air distribution
- manual recirculation mode
- 4-speed blower as well as combined pollutant and pollen filter
- 4 air vents in the dashboard
- footwell vents, front and rear

| Closing systems

Convenience key

access and drive authorisation system where the vehicle key only needs to be carried with you; the engine is started and stopped via the engine start-stop button; the vehicle is locked and unlocked from the outside via sensors on the driver and front-passenger door handles; separate opening of the luggage compartment lid possible even when the vehicle is locked

Luggage compartment lid, electrically opening and closing

opens via a button on the vehicle key or in the driver door or by means of the soft-touch button in the luggage compartment lid handle recess; closes via a button on the inside of the luggage compartment lid, the button in the driver door or the optional convenience key (long press). In conjunction with the convenience key, it is possible to close the luggage compartment lid and simultaneously lock the car via an additional button on the inside of the luggage compartment lid. Including power-assisted closing and programmable luggage compartment lid opening angle

Anti-theft alarm

monitors doors, bonnet and luggage compartment lid; includes interior monitoring (can be deactivated), tow-away protection via angle of inclination sensor and signal horn independent of vehicle electrical system; with safety guarantee: prevents doors being opened from the inside as soon as the vehicle has been locked using the vehicle key

Preparation for tracking system

preparation for connecting a tracking system (available from Audi Genuine Accessories) that enables a stolen vehicle to be located and tracked

| Storage/transport



Storage compartments

storage compartment in the door trims, including bottle holder (1.5 l) at front and storage compartment in the front centre console; glove compartment on the front-passenger side



Luggage compartment package

flexible transport of objects and convenient for travel; comprising:

- luggage compartment net for attaching to lashing points on the luggage compartment floor
- net at the side
- 12V socket
- additional luggage compartment light on the left

Storage package

- storage net on the back of the front-seat backrests
- storage compartment under the front seats
- lockable glove compartment
- multi-fastening point in the front-passenger footwell

Storage and luggage compartment package

contains the features of the storage and luggage compartment package



Luggage compartment cover, extendable

removable; including luggage compartment roller shutter



Through-loading facility

provides extended loading possibility for the practical transportation of long objects; including centre armrest, rear, with cup holders and storage compartment

Reversible mat

for covering the luggage compartment, can also be used with the rear seat backrest folded down; in velour on one side and rubber-coated on the other; with fold-out protective film for the loading sill and bumper

Reversible luggage compartment floor

one side in high-quality dilour, the other side waterproof and hard-wearing, additional storage compartments under the reversible luggage compartment floor

Loading sill protector in stainless steel

Trailer towing hitch

mechanically swivelling, bar and ball head made from forged steel; operated via pull-button in the luggage compartment, with control light in the luggage compartment and display in instrument cluster to monitor secure attachment of trailer towing hitch. The 13-pin socket can be swivelled out of sight behind the bumper skirt and permits the continuous operation of electrical devices in the trailer or caravan while driving. Trailer stabilisation via the Electronic Stabilisation Control (ESC)

Provision for trailer towing hitch

includes preparation for the control units and a reinforced engine cooling. The trailer towing hitch for retrofitting is available from Audi Genuine Accessories.

| MMI®/navigation

**Navigation package**

includes:

- connectivity package
- navigation function
- navigation data on SD card¹
- maps shown on 6.5-inch colour display

operation via MMI radio, multifunction sport leather steering wheel or voice control system

Driver information system with colour display

shows the information of the driver information system on a high-resolution colour display with an even better overview and improved readability; additional information display option for optional assistance systems and additional display content from the MMI system

Driver information system

displays a host of useful vehicle information on a 3.5-inch monochrome display in the driver's direct field of vision. Attention assist provides a warning in the driver information system and via acoustic signal if the system determines that the driver's attention is lapsing. The system is active between 65 and 200 km/h and can be deactivated. An integrated efficiency program provides consumption data overviews.

**MMI® navigation plus**

- navigation system¹
- high-resolution 7-inch colour display
- map display with topographical map colouring, display of lots of sightseeing information and city models in 3D, choice of three alternative routes
- rotary/push-button control with integrated joystick function to search on the map
- split-screen mode for route information (manoeuvring points, points of interest on motorways, TMCpro on route), detailed junction map and lane recommendation
- dynamic route guidance with TMCpro (in conjunction with Audi connect: traffic information online²)
- voice control system with whole-word entry of address in a single sentence
- additional arrow display in the driver information system
- includes radio with 3-way tuner and phase diversity
- hard drive can also be used to store music (20 GB)
- DVD player (MP3, WMA, AAC and MPEG-4 compatible), can be used for music CDs and video DVDs
- 2 SDHC card readers (up to 32 GB)
- Audi music interface
- Bluetooth interface with Bluetooth audio streaming
- 8 passive loudspeakers, total output 80 watts
- use of services supported by Audi connect³

| Entertainment

**Audi radio**

- monochrome 3-inch display
- CD player (MP3 compatible) and AUX-IN connection
- 24 station memory, FM (VHF) and AM (MW) reception range; speed-sensitive volume adjustment
- 4 passive loudspeakers at front, total output 40 watts

**MMI® radio**

- integrated MMI control concept with offset 6.5-inch colour display and car menu
- CD drive and SDHC memory card reader (up to 32 GB), both MP3, WMA and AAC compatible and AUX-IN connection
- 50-station memory with dynamic station list, FM (VHF) and AM (MW) reception; phase diversity and speed-dependent volume control, TP memo function whilst driving
- 8 passive loudspeakers at the front and rear, total output 80 watts

Digital Audio Broadcasting

In addition to the range of analogue stations, reception of digitally broadcast radio stations⁴ according to DAB standard, including DAB+ and DMB audio; display of information accompanying the programme (e.g. artist and title, depending on provision by the respective radio station) as well as additional information in the form of a slide show (e.g. cover and weather).

Digital TV reception

reception of digitally-broadcast, uncoded television stations⁴ (in DVB-T standard with MPEG-2 or MPEG-4 standard) as well as DVB-T audio stations; display of information accompanying the programmes such as teletext and Electronic Programme Guide (EPG); automatic station search; external AV-IN connection via adapter cable; no picture possible when the vehicle is moving

Audi music interface

Portable media players⁵ such as Apple iPod/iPhone (music functionality) and USB storage media and MP3 players may be connected to the vehicle. Located in the centre console; operation via MMI or radio control or the multifunction leather steering wheel. Part of the connectivity package, navigation package and MMI navigation plus. Specific Audi Genuine Accessories adapter cables are required to connect portable media players or USB storage media. Adapter cables matching respective devices can also be selected. Additional adapter cables are available from Audi Genuine Accessories. In conjunction with the Audi music interface, the AUX-IN connection is omitted.

Audi music interface online^{5, 6}

extends the Audi music interface by the following functions: internet radio stations and podcasts can be recorded via your Wi-Fi home network and played in the vehicle. Internet radio stations can be listened to live in the vehicle. The Audi music interface online makes it possible to create a Wi-Fi hotspot in the vehicle (by using a USB broadband modem).

**Bose Surround Sound**

impressive surround sound reproduction through 10-channel amplifier with a total output 465 watts and 14 loudspeakers including centre speaker and subwoofer; AudioPilot® for noise-dependent volume adjustment and 5.1 surround sound in conjunction with MMI navigation plus; powerful and accurate bass reproduction, lifelike sound with natural tone and a feeling of space for an impressive sound experience. A particular design highlight is the floating effect of the front loudspeakers created by indirect lighting in LED technology.

Audi sound system

impressive sound thanks to 6-channel amplifier with a total output of 180 watts as well as 10 loudspeakers including centre speaker and subwoofer

¹ Navigation data available for supported countries on integrated memory or SD card. For more information, please contact your Audi partner. ² The traffic information online Audi connect service is available for several countries.

For more information, please contact your Audi partner. ³ Requires the optional equipment Audi connect including car phone. ⁴ Reception depends on digital network availability. ⁵ Please contact your Audi partner or visit www.audi.com/mp3

for information on compatible media players. ⁶ From quattro GmbH.

| Communication

Audi connect including car phone

Use of Audi connect and more convenient phoning thanks to integrated car phone; the vehicle is connected to the internet via an integrated data module. Import of phone book entries and call list management possible.

The following services supported by Audi connect are currently available in your model:

Mobility & navigation

- Point-of-interest (POI) search with voice control
- Traffic information online¹
- Country information
- Fuel prices
- Parking information
- Navigation with Google Earth™² and Google Street View™²
- Destination entry via myAudi or Google Maps™²

Communication

- Wi-Fi hotspot

Infotainment

- Weather
- Audi music stream
- News online
- Travel information

Use of the services supported by Audi connect is possible only with the optional MMI navigation plus equipment and with Audi connect including car phone. You also require a SIM card with data option – with car phone a SIM card with phone and data option or a Bluetooth-capable smartphone³ with remote SIM Access Profile (rSAP). There is a reader for your SIM card in the surround of the MMI navigation plus. The services are available only with an existing or separate mobile phone contract and only within the range of the respective mobile phone network. Additional costs may be incurred when receiving data packets from the internet, depending on the terms of your mobile phone contract, particularly when used abroad. Because of the high data volumes involved, a data flat rate is strongly recommended.

The availability of the services supported by Audi connect varies from country to country. The Audi connect services are provided for at least 1 year from vehicle delivery. After 24 months have expired, the Audi connect services will be extended free of charge once for 12 months. If you do not require this free extension, please write to:

AUDI AG
Audi International Customer Care Services
D-85045 Ingolstadt
Email: kundenbetreuung@audi.de
Tel.: + 49 (0) 800-2834 7378423

The city events service and possibly additional services are available to customers for 12 months. Ask your Audi partner about a subsequent extension of the Audi connect services.

Please visit www.audi.com/connect or contact your Audi partner for more detailed information about Audi connect; contact your mobile services provider for information about contract conditions.

Audi MMI® connect app

The Audi MMI connect app available for some smartphones³ supports the following Audi connect services:

- Audi music stream
- Point-of-interest (POI) search with voice control
- Destination entry via myAudi or Google Maps™²
- Traffic information online¹

Bluetooth interface

allows hands-free calls to be made in the vehicle using the microphone and – depending on mobile phone compatibility³ – Bluetooth audio streaming. Bluetooth-capable mobile phones can be connected to the vehicle via the interface.

Audi phone box³

allows phone calls with improved reception quality by placing mobile phone into the universal phone holder near the centre armrest, front; hands-free facility and voice control (telephone); low SAR radiation in the interior of the vehicle thanks to connection to vehicle aerial; operated via radio/navigation systems or the multifunction leather steering wheel; can be charged via USB port

Connectivity package

combines the following features:

- Audi music interface
- Bluetooth interface with Bluetooth audio streaming
- preparation for navigation system (navigation function and map data available as retrofit solution from Audi Genuine Accessories)
- additional SDHC card reader (for up to 32 GB)

In conjunction with the Audi music interface, the AUX-IN connection is omitted.

| Assistance systems

Hold assist⁴

holds the vehicle over an indefinite period of time on the uphill or downhill gradients usual in traffic. The system is activated via push-button and allows the driver to drive away smoothly.

Hill descent control⁴

maintains selected speed on downhill drives; activated by pushing a button

Parking system, rear⁴

makes reverse parking easier by indicating acoustically how far away the vehicle is from an object detected behind the vehicle; measurement is by ultrasonic sensors integrated discreetly in the bumper; active when reverse gear is selected



Parking system plus with reversing camera⁴

acoustic and visual parking system, front and rear; image of area behind the vehicle shown on the MMI display, with dynamic display modes showing the path calculated based on steering angle; auxiliary lines and guidelines as well as indication of the point at which to apply opposite lock when parallel parking; reversing camera integrated discreetly in the handle strip of the luggage compartment lid; activated when reverse gear is selected or via a button on the centre console

Parking system plus⁴

acoustic and visual parking system, front and rear assists with parking and manoeuvring; display in MMI display; measurement is by ultrasonic sensors integrated discreetly in the bumpers; activated when reverse gear is selected or via a button on the centre console

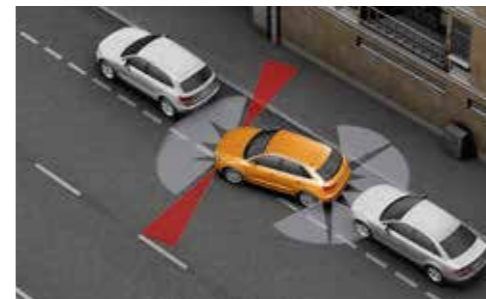

Park assist⁴

virtually automatic steering process during parking. Uses ultrasonic sensors to search for suitable perpendicular and parallel parking spaces. The ideal parking path is calculated for perpendicular parking spaces, and the ideal path for leaving the parking space is additionally calculated for parallel parking spaces. The steering action is performed by the system. The driver must accelerate, apply the brakes and monitor the parking process. The display of surroundings can, depending on the steering angle, warn of any obstacles at the side of the vehicle by displaying the lane in conjunction with MMI navigation plus. Assisted parking is even possible in smaller parking spaces and bend areas. Parking in several moves is supported. Can optionally be ordered with reversing camera; activated via a button on the centre console

Park assist and reversing camera⁴

functions as parking system plus with reversing camera and park assist. See the description of the respective assistance system for information on activation or adjustment.

Cruise control⁴

At speeds of 30 km/h and above, the system keeps the set speed constant if engine power and engine braking effect permit it; operated via separate steering column stalk, set speed displayed in driver information system



Audi side assist⁴

warns by means of an LED display on the relevant exterior mirror of any situations assessed as critical for lane-changing. Radar sensors detect vehicles approaching from behind at the side and measure the distance and the difference in speed. The lane change assistant provides support in the speed range from around 30 km/h. In conjunction with the optional Audi active lane assist, the display in the corresponding mirror may flash even if you did not indicate: if you approach a detected boundary line and are on the verge of drifting out of your lane, Audi side assist uses this method to warn you of detected vehicles that are classified as critical. Activated via a button in the mirror quadrant

¹The traffic information online Audi connect service is available for several countries. For more information, please contact your Audi partner. ²Google and the Google logo are registered trademarks of Google Inc.

³Please contact your Audi partner or visit www.audi.com/bluetooth for information on compatible mobile phones. ⁴Please note: The systems work only within system limits and support the driver.

However, the driver remains responsible for driving the vehicle and is required to be attentive at all times.

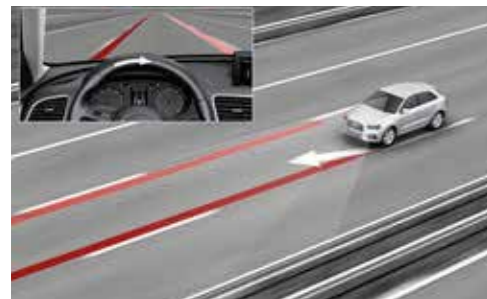

Audi active lane assist¹

helps you to keep in lane by means of gentle steering intervention. The lane compliance assistant is triggered when the driver starts to cross detected lane markings without activating an indicator. The system provides assistance from speeds of around 60 km/h. Steering wheel vibration can be adjusted if the driver wishes. In conjunction with MMI navigation plus, the system includes the camera-based recognition of traffic signs. Including high-beam assist; activated via a button on the steering column stalk of the indicator



Camera-based recognition of traffic signs^{1,2}

Traffic sign recognition for overtaking bans and speed limits, including temporary speed limit displays (e.g. above motorways); situation-dependent evaluation in wet conditions and in fog, speed limits depending on the time of day and when using a trailer³. The traffic sign recognition feature can detect standardised speed limits within the viewing range of the camera within system limits. Supported by Audi connect navigation data, the detected limits are evaluated and automatically shown in the driver information system. Traffic sign recognition output can be configured via the multifunction steering wheel. Up to 3 traffic signs can be exclusively shown in the display of the instrument cluster or the relevant speed limit at the current time as additional display for another system (e.g. digital speed limit display). The system has purely informative character, there is no manipulation and no warning if the displayed speed is exceeded.

| Driving dynamics/brakes



Audi drive select

sets the vehicle characteristics in the available modes auto, comfort, dynamic and efficiency by adapting the power steering assistance, engine or gear changing characteristics (for S tronic) and sets other optional equipment. The efficiency mode shifts the engine, transmission (for S tronic), climate control and optional adaptive cruise control or cruise control to a more fuel-efficient basic setting.

Suspension with comfortable tuning

- sporty, dynamic driving characteristics thanks to impressive driving dynamics and agile handling
- McPherson front axle with lower aluminium wishbones
- 4-link rear axle with separate spring/damper arrangement

S line sport suspension

dynamic suspension tuning and vehicle lowered by 20 mm

Suspension with damper control

based on the standard suspension with comfortable tuning with electronically controlled adaptation to different driving situations; dynamic or comfort-oriented characteristic of the damper coordination can be adapted via Audi drive select

Front-wheel drive

distribution of drive forces on the front wheels; with Electronic Differential Lock (EDL) and wheel-selective torque control via braking intervention on all driven wheels, Anti-Slip Regulation (ASR) and Electronic Stabilisation Control (ESC) with brake assist

quattro®

permanent all-wheel drive with electronically controlled multi-plate clutch on the rear axle as well as wheel-selective torque control and Electronic Differential Lock (EDL) on all driven wheel; distribution of driving forces depending on the driving situation to each individual wheel for precisely controlled, sporty handling; quattro emblem in the Audi Singleframe, on the luggage compartment lid and on the passenger side of the dashboard

S tronic®

6-speed or 7-speed dual-clutch transmission with electrohydraulic actuation allows faster gear changing and gear changes with virtually no perceptible break in propulsive power. Including coasting mode in efficiency mode: when the accelerator is released the drivetrain is opened and the engine automatically switches to neutral. In automatic mode, programmes D (Drive) and S (Sport) can be selected. S tronic can be manually operated by means of the selector lever or the optional shift paddles behind the steering wheel. Includes hill hold assist

Electromechanical parking brake

includes parking brake function when stationary, drive-off assistance function through automatic release when driving away and maximum deceleration action while driving acting on all 4 wheels

Electromechanical power steering

combines precision and comfort with exceptional energy-saving technology. The electromechanical steering ensures stability at high speeds whilst being light and precise when parking and manoeuvring. With active countersteering which gives the driver a steering recommendation for the better stabilisation of the vehicle

| Technology/safety

Recuperation

economises on fuel through brake energy recovery; kinetic energy is converted into usable electrical energy by increasing the generator voltage when the vehicle is coasting or braking and relieving the generator during subsequent acceleration

Start-stop system

helps to reduce fuel consumption and CO₂ emission by automatically switching off the engine when stationary, e.g. at traffic lights. The engine is restarted as soon as the clutch is pressed (manual transmission) or the footbrake is released (automatic transmission). May be deactivated using a button at any time

ISOFIX child seat mounting and top tether for the outer rear seats

standard mounting for practical attachment of ISOFIX child-seats; including additional fastening point (top tether).

You can obtain the recommended child seats from your Audi partner.

ISOFIX child seat mounting for the front-passenger seat

with front-passenger airbag deactivation switch, includes separate electric child-proof lock for the rear doors

| Audi Extended Warranty

Audi Extended Warranty

The Audi Extended Warranty provides extended risk cover and cost control beyond the first 2 years of the manufacturer's warranty for a variety of claims. It can be ordered directly and only on purchase of a new car. Choose from nine combinations of service life and mileage. For more information, please contact your Audi partner.



Further information can be obtained from the Audi Q3 accessories catalogue, at www.audi.com, and from your Audi partner.

Cast aluminium winter wheels in 5-arm semi-Y design

Complete winter wheel in size 6.5 J x 17 with 215/60 R 17 tyres¹, can be fitted with snow chains. The dynamic design accentuates your Audi Q3.

Audi Genuine Accessories. As individual as the life you lead.

Dynamic movement from A to B. And then, inspired, just keep driving. This is par for the course with your Audi Q3. Not least because it is prepared for a multitude of individual requirements from A to Z. Thanks to Audi Genuine Accessories: products that will inspire you to new destinations again and again. And keep all our quality promises day in, day out. Benefit from customised solutions with convincing design and functionality. Because creativity in development and high production standards alongside numerous testing procedures are just as decisive for Audi Genuine Accessories as for the Audi vehicles themselves. Discover which tailor-made ideas Audi Genuine Accessories have ready for your lifestyle. A few highlights are illustrated here – please contact your Audi partner for more information on the complete range.



Ski and luggage boxes²

New Audi design with improved aerodynamics thanks to a flat, sporty look. Available in the colours platinum grey with brilliant black sideblade and gloss brilliant black, each with chrome-plated Audi rings; in top-quality, rivet-free look. Can be locked and opened on both sides for convenient loading and unloading. With inner handle for pulling the box closed. Simple quick-attachment system incl. torque restriction. Position moved forward for better access to the luggage compartment. Available in 3 sizes: 300 l, 360 l (image above) and 405 l. Ideal supplement: the roof box bags to make optimum use of the Audi roof boxes. Available in 3 sizes: S (43 l), M (76 l) and L (82 l).

Audi tracking system plus (not illustrated)

enables a stolen vehicle to be located and tracked via GPS/GSM technology in 27 European countries. With automatic driver recognition and intelligent restart inhibitor. For detailed information, please contact your Audi partner.

Rubber floor mats

A perfect fit. Provide better protection against coarse soiling. Connected to the vehicle through the attachment points on the vehicle floor. With Q3 logo.



Roof rack bag

For storage or transportation of carrier unit and smaller roof rack modules. Made of robust material, with several loops and side pocket for matching tools or small parts. Available in 2 sizes.



The fuel consumption and CO₂ emission figures can be found from page 88 onwards.

¹You will find specifications on the technical characteristics of tyres on page 92. ²For information on when the ski and luggage box in brilliant black will be available, please contact your Audi partner.

iPad adapter

Adapter for Apple iPads for attachment to the backrests of the front seats. The adapters can easily be attached to a separately available holder for mobile devices. The operability of iPads remains unaffected. With integrated charging function and 90-degree rotation. Condition: preparation for Rear Seat Entertainment in the vehicle.

**Business case**

More room for your everyday accessories. The high-quality business case has a volume of approx. 14 l – for a laptop up to 15 inches in size plus various office utensils. Safe attachment on the rear seat bench or on the front-passenger seat using the 3-point seat belt. Can also be used outside the vehicle as an attractive briefcase.

**Clothes hanger**

For jackets, sports jackets and other pieces of clothing. The clothes hanger is mounted on the front head restraints.

**Running boards**

Made of stainless steel. Make it easier to store utensils in the ski and luggage box on the roof. Rubber pads reduce the risk of sliding. Load capacity of 200 kg each.

**Luggage compartment liner**

Custom-fit, washable and sturdy luggage compartment protection. Edge protects the luggage compartment floor better from leaked liquids.

ISOFIX base for Audi baby seat and Audi child seat (not illustrated)

For a better support of the Audi baby seat and the Audi child seat. Enables quick mounting and dismounting. The adjustable support foot provides additional stability. Optimises the level of protection for the child. Note: the ISOFIX base is optional for the baby seat, but for the child seat it is absolutely required.

Audi child seat

Can be used facing forwards or backwards. With adjustable seat, integrated safety harness and adjustable head restraint. Cloth cover can be removed and washed, is breathable and gentle on the skin, certified in accordance with Oeko-Tex® standard 100. Can only be used in conjunction with the ISOFIX base. Suitable for children from 9 to 18 kg (approximately 1 to 4 years). Also available: Audi child seat youngster plus for children from 15 to 36 kg (approximately 4 to 12 years) and Audi baby seat for infants up to 13 kg (approximately 12 months). All child seats are available in the colours Misano red/black and titanium grey/black.



	Technical data	Dimensions	Standard/optional equipment
Model	Audi Q3 1.4 TFSI ultra (110 kW)	Audi Q3 2.0 TDI ultra (110 kW) ¹	Audi Q3 2.0 TFSI quattro (132 kW)
Engine type	4-cylinder inline petrol engine with direct fuel injection, turbocharging and Audi cylinder on demand technology	4-cylinder inline diesel engine with common rail injection system and turbocharging	4-cylinder inline petrol engine with direct fuel injection and turbocharging
Displacement in cc (valves per cylinder)	1,395 (4)	1,968 (4)	1,984 (4)
Max. output ² in kW at rpm	110/5,000–6,000	110/3,500–4,000	132/4,000–6,200
Max. torque in Nm at rpm	250/1,500–3,500	340/1,750–2,800	320/1,400–3,900
Power transmission			
Drive type	Front-wheel drive	Front-wheel drive	quattro [®] permanent all-wheel drive
Transmission type	6-speed manual transmission	6-speed manual transmission	6-speed manual transmission [7-speed S tronic]
Weights/capacities			
Unladen weight ⁴ in kg	1,460	1,560	1,580 [1,615]
Gross vehicle weight in kg	1,985	2,085	2,105 [2,140]
Permissible roof load limit/nose weight in kg	75/80	75/80	75/80 [75/80]
Trailer load limit ⁵ in kg			
unbraked	730	750	750 [750]
12 % gradient	1,800	1,800	1,800 [2,000]
8 % gradient	1,800	1,800	1,800 [2,000]
Fuel tank capacity, approx. in l	64	64/AdBlue ^{®6} tank: 12	64 [64]
Performance/consumption ⁷			
Top speed in km/h	204	204 ⁸	217 [217]
Acceleration 0–100 km/h in s	9.2	9.6	7.6 [7.6]
Fuel grade	Sulphur-free super RON 95 ⁹	Sulphur-free diesel ¹⁰	Sulphur-free super RON 95 ⁹
Fuel consumption ¹¹ in l/100 km			
urban	6.8–6.6	5.5–5.2	8.6–8.3 [8.4–7.8]
extra-urban	5.2–4.9	4.4–3.9	6.2–5.8 [6.3–5.7]
combined	5.8–5.5	4.8–4.4	7.2–6.8 [7.0–6.5]
CO ₂ emission ¹¹ in g/km			
urban	158–152	143–134	197–189 [193–180]
extra-urban	120–113	115–103	131–122 [146–132]
combined	134–127	126–114	156–146 [161–149]
Emission standard	EU6	EU6	EU6 [EU6]

Audi Q3 2.0 TDI ultra (110 kW 114 g CO₂/km)

Specific technical measures in the vehicle lead to lower fuel consumption and reduced CO₂ emissions compared with other Audi Q3 models.

The Audi Q3 2.0 TDI ultra (110 kW 114 g CO₂/km) is equipped with the following as standard:

- 6-speed manual transmission
- Fuel-saving tyres with improved rolling resistance
- Forged aluminium wheels in 7-arm design, size 6.5 J x 16 with 215/65 R 16 tyres³
- S line sport suspension for a low drag coefficient and improved aerodynamics

The following equipment is not available for the Audi Q3 2.0 TDI ultra (110 kW 114 g CO₂/km):

- Q3 sport
- Q3 design

	Technical data	Dimensions	Standard/optional equipment
Model	Audi Q3 1.4 TFSI (110 kW)	Audi Q3 1.4 TFSI (110 kW)	Audi Q3 2.0 TFSI (132 kW)
Engine type	4-cylinder inline petrol engine with direct fuel injection, turbocharging and Audi cylinder on demand technology	4-cylinder inline petrol engine with direct fuel injection and turbocharging	4-cylinder inline petrol engine with direct fuel injection and turbocharging
Displacement in cc (valves per cylinder)	1,395 (4)	1,395 (4)	1,984 (4)
Max. output ² in kW at rpm	110/5,000–6,000	110/5,000–6,000	132/4,000–6,200
Max. torque in Nm at rpm	250/1,500–3,500	250/1,500–3,500 [1,750/–3,000]	320/1,400–3,900
Power transmission			
Drive type	Front-wheel drive	Front-wheel drive	Front-wheel drive
Transmission type	[6-speed S tronic]	6-speed manual transmission [6-speed S tronic]	6-speed manual transmission
Weights/capacities			
Unladen weight ⁴ in kg	[1,480]	1,460 [1,480]	1,495
Gross vehicle weight in kg	[2,005]	1,985 [2,005]	2,020
Permissible roof load limit/nose weight in kg	[75/80]	75/80 [75/80]	75/80
Trailer load limit ⁵ in kg			
unbraked	[740]	730 [740]	740
12 % gradient	[1,800]	1,800 [1,800]	1,800
8 % gradient	[1,800]	1,800 [1,800]	1,800
Fuel tank capacity, approx. in l	[64]	64 [64]	64
Performance/consumption ⁷			
Top speed in km/h	[204]	204 [204]	217
Acceleration 0–100 km/h in s	[8.9]	9.2 [8.9]	8.2
Fuel grade	Sulphur-free super RON 95 ⁹	Sulphur-free super RON 95 ⁹	Sulphur-free super RON 95 ⁹
Fuel consumption ¹¹ in l/100 km			
urban	[7.4–7.0]	7.4–7.1 [7.7–7.2]	8.6–8.3
extra-urban	[5.5–5.1]	5.3–5.0 [5.7–5.1]	5.7–5.3
combined	[6.2–5.8]	6.1–5.8 [6.4–5.9]	6.8–6.4
CO ₂ emission ¹¹ in g/km			
urban	[170–162]	172–164 [177–166]	197–189
extra-urban	[127–119]	123–114 [130–119]	131–122
combined	[143–134]	141–133 [147–136]	156–146
Emission standard	[EU6]	EU6 [EU6]	EU6

[] Data in square brackets refers to S tronic. Explanation of ¹ to ¹¹ on page 91.

Model	Audi Q3 2.0 TDI (88 kW) ¹	Audi Q3 2.0 TDI (110 kW) ¹	Audi Q3 2.0 TDI quattro (110 kW) ¹	Audi Q3 2.0 TDI (135 kW) ¹	Audi Q3 2.0 TDI quattro (135 kW) ¹
Engine type	4-cylinder inline diesel engine with common rail injection system and turbocharging	4-cylinder inline diesel engine with common rail injection system and turbocharging	4-cylinder inline diesel engine with common rail injection system and turbocharging	4-cylinder inline diesel engine with common rail injection system and turbocharging	4-cylinder inline diesel engine with common rail injection system and turbocharging
Displacement in cc (valves per cylinder)	1,968 (4)	1,968 (4)	1,968 (4)	1,968 (4)	1,968 (4)
Max. output ² in kW at rpm	88/3,250–4,500	110/3,500–4,000	110/3,500–4,000 [4,000]	135/3,500–4,000	135/3,500–4,000
Max. torque in Nm at rpm	290/1,500–2,750	340/1,750–2,800	340/1,750–2,800	380/1,800–3,250	380/1,800–3,250
Power transmission					
Drive type	Front-wheel drive	Front-wheel drive	quattro® permanent all-wheel drive	Front-wheel drive	quattro® permanent all-wheel drive
Transmission type	6-speed manual transmission	6-speed manual transmission	6-speed manual transmission [7-speed S tronic]	6-speed manual transmission	6-speed manual transmission [7-speed S tronic]
Weights/capacities					
Unladen weight ⁴ in kg	1,560	1,560	1,645 [1,680]	1,595	1,680 [1,700]
Gross vehicle weight in kg	2,085	2,085	2,170 [2,205]	2,120	2,205 [2,225]
Permissible roof load limit/nose weight in kg	75/80	75/80	75/80 [75/80]	75/80	75/80 [75/80]
Trailer load limit ⁵ in kg unbraked	750	750	750 [750]	750	750 [750]
12 % gradient	1,800	1,800	1,800 [2,000]	2,000	2,000 [2,000]
8 % gradient	1,800	1,800	1,800 [2,000]	2,000	2,000 [2,000]
Fuel tank capacity, approx. in l	64/AdBlue tank: 12	64/AdBlue tank: 12	64/AdBlue tank: 12	64/AdBlue tank: 12	64/AdBlue tank: 12
Performance/consumption⁷					
Top speed in km/h	190	204	204 [204]	219	219 [219]
Acceleration 0–100 km/h in s	10.9	9.6	9.3 [9.3]	8.2	7.9 [7.9]
Fuel grade	Sulphur-free diesel ¹⁰	Sulphur-free diesel ¹⁰	Sulphur-free diesel ¹⁰	Sulphur-free diesel ¹⁰	Sulphur-free diesel ¹⁰
Fuel consumption ¹¹ in l/100 km urban	5.9–5.6	5.5–5.2	6.1–5.8 [6.5–6.1]	6.6–6.2	7.0–6.5 [6.6–6.3]
extra-urban	4.5–4.1	4.4–4.1	4.7–4.4 [4.9–4.5]	4.6–4.2	4.9–4.5 [4.9–4.4]
combined	5.0–4.6	4.8–4.5	5.4–4.9 [5.5–5.1]	5.3–4.9	5.7–5.2 [5.6–5.1]
CO ₂ emission ¹¹ in g/km urban	154–145	143–136	159–152 [171–159]	172–163	182–171 [176–165]
extra-urban	118–108	115–106	124–115 [128–116]	119–110	128–117 [128–117]
combined	131–121	126–118	140–129 [144–132]	138–129	148–137 [146–134]
Emission standard	EU6	EU6	EU6 [EU6]	EU6	EU6 [EU6]

Explanatory notes

- Refill the separate AdBlue tank as indicated by the information in the display of the instrument cluster. We recommend having the AdBlue tank refilled by your Audi partner.
- The figure given was calculated using the specified measuring procedure (current version of UN-R 85).
- You will find specifications on the technical characteristics of tyres on page 92.
- Unladen vehicle weight includes driver (75 kg) and fuel tank 90 % full, calculated in accordance with the current version of Reg. (EU) 1230/2012. Optional equipment may increase the car's unladen weight and drag coefficient, whereupon the possible payload limit and the top speed will be reduced accordingly.
- The engine's power output always decreases with increasing altitude. At 1,000 m above sea level, and for every additional 1,000 m, deduct 10 % from the weight of the outfit (trailer load limit + gross weight of the towing vehicle). Figure for trailer load limit applies to factory-fitted trailer towing hitch. If using the vehicle with a trailer towing hitch for commercial purposes, a digital tachograph may be required under certain conditions.
- Registered trademark of the Verband der Automobilindustrie e. V. (VDA).
- Fuel consumption and CO₂ emission figures given in ranges depend on the tyre/wheel sets used.
- Regulated.
- We recommend using sulphur-free super unleaded RON 95 fuel complying with DIN EN 228. If this is not available, use sulphur-free regular unleaded RON 91 fuel complying with DIN EN 228; power output will be slightly reduced. Unleaded RON 95 fuel with a maximum ethanol content of 10 % (E10) can generally be used. Fuel consumption details refer to operation with RON 95 fuel complying with 692/2008/EC.
- We recommend using sulphur-free diesel complying with DIN EN 590. If this is not available, use diesel complying with DIN EN 590.
- The figures given were calculated using the specified measuring procedures. The figures do not refer to one individual vehicle and do not form part of any offer, but rather should be used purely for purposes of comparison between the different vehicle models.













Important note

Special information about the wheels: Wheels with gloss turned finish as well as polished or partly polished aluminium wheels must not be used in wintry road conditions. For manufacturing reasons, the rim surface does not have sufficient corrosion protection for such use and can be damaged permanently by road salt or similar.

[] Data in square brackets refers to S tronic. Explanation of ¹ to ¹¹ on page 91.

Classifications of tyre parameters

The table shows the range of fuel efficiency, wet grip and exterior noise emission classes for the different tyre sizes of the Audi Q3.

	Tyre size	Fuel efficiency class	Wet grip class	Exterior noise emission class
Summer tyres	215/65 R 16	F-B	C-A	71-67  - 
	235/55 R 17	E-C	B-A	71  - 
	235/50 R 18	E-C	B-A	72-71 
	255/40 R 19	E-C	B	73-71 
Winter tyres	255/35 R 20	E	B	73-70  - 
	215/65 R 16	E-C	E-B	73-69  - 
All-season tyres	215/60 R 17	E-C	E-B	72-68  - 
	235/55 R 17	E	C	67 

It is not possible to order a specific tyre. Ask your Audi partner about the range of tyres available in your country.

Audi Q3

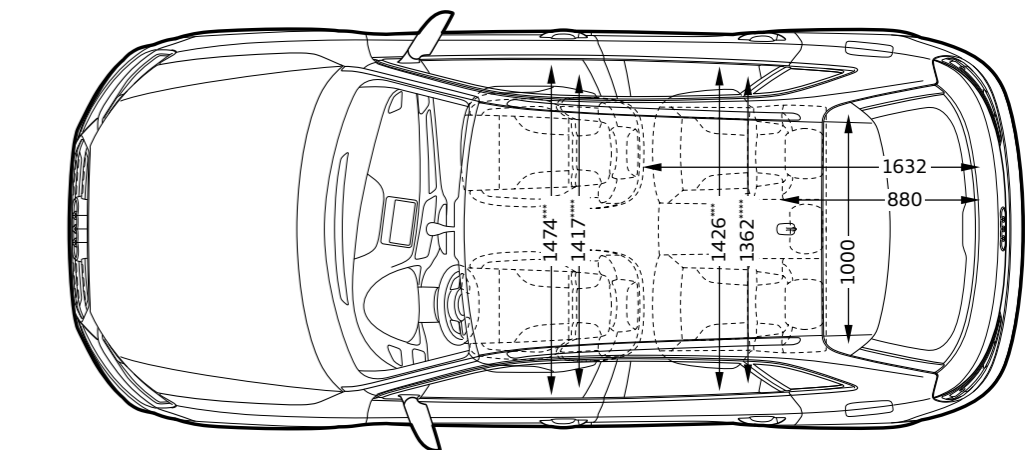
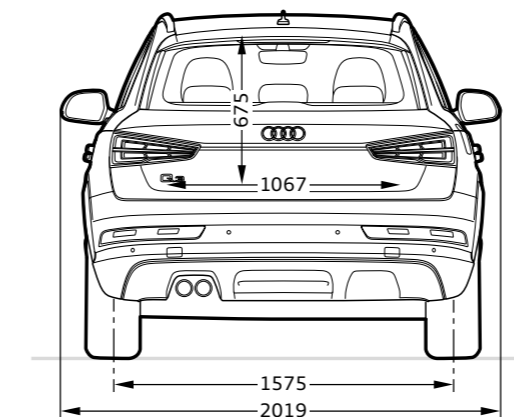
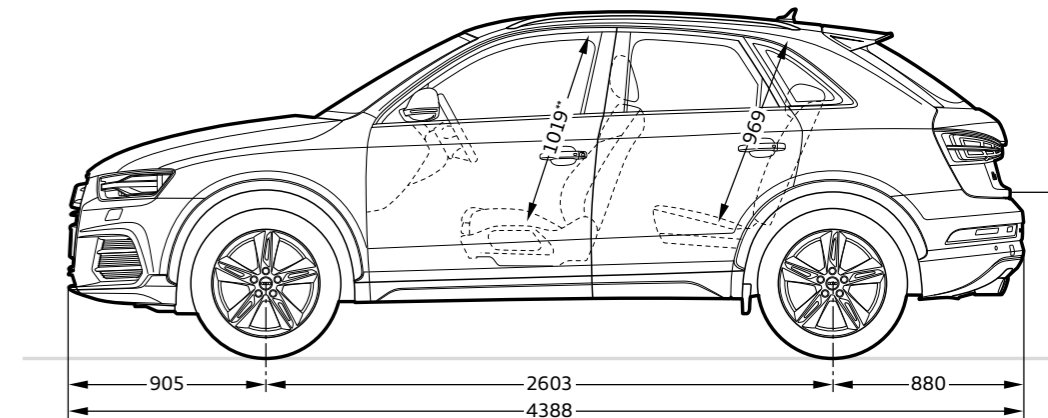
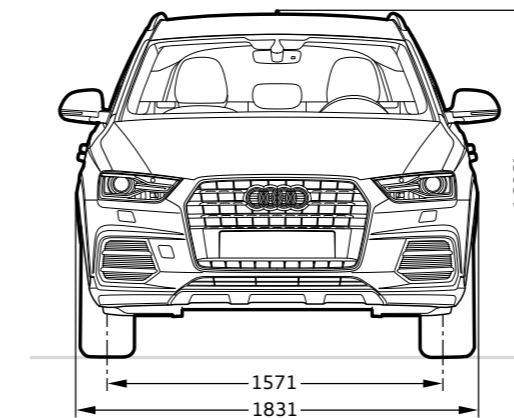

Dimensions in millimetres.











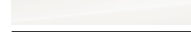

Dimensions were measured with unladen vehicle weight.

Luggage capacity in l: 460/1,365 (second value with the rear seat backrest folded down and vehicle loaded up to roof height).

Turning circle approx. 11.8 m.

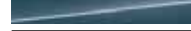
*Without roof aerial the vehicle height is reduced by 18 mm. **Maximum headroom.









Elbow room width. *Shoulder room width.









	Page	Q3	Q3 sport	Q3 design
Lines and packages	50			
S line exterior package		■	■	■
S line sport package		–	■	–
Audi exclusive design exterior package		■	■	■
Audi exclusive design package		–	–	■
Solid paint finishes	62			
 Cortina white		□	□	□
 Brilliant black		□	□	□
Metallic paint finishes	62			
 Glacier white, metallic		■	■	■
 Cuvée silver, metallic		■	■	■
 Floret silver, metallic		■	■	■
 Monsoon grey, metallic		■	■	–
 Hainan blue, metallic		■	■	■
 Utopia blue, metallic		■	■	■
 Tundra brown, metallic		■	■	■
 Mythos black, metallic		■	■	■
Pearl effect paint finishes	63			
 Daytona grey, pearl effect		■	■ ¹	■
 Misano red, pearl effect		■	■	■
Customised paint finishes	63			
 Audi exclusive customised paint finishes		■	■	■
Contrasting/full paint finishes	63			
Contrasting paint finish ²		–	–	□
Full paint finish		–	□	–

□ Standard equipment ■ Optional equipment – Not available

Country-specific variations possible. Please find out from your local Audi partner which equipment is standard and what optional equipment is available in your country.







More detailed descriptions of a selection of items from the equipment range can be found from page 42 onwards.







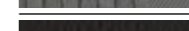
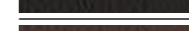

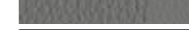



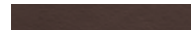
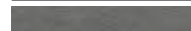

	Page	Q3	Q3 sport	Q3 design
Wheels/tyres	64			
 16" forged aluminium wheels in 7-arm design		□	–	–
 17" cast aluminium wheels in 5-arm Trias design		■	■	■
 17" cast aluminium wheels in 10-spoke design		■	■	■
 17" cast aluminium wheels in 5-V-spoke design		–	–	□
 17" cast aluminium wheels in 5-spoke Y design		–	□	–
 18" Audi Sport cast aluminium wheels in 5-arm offroad design		■	■	■
 18" Audi Sport cast aluminium wheels in 5-twin-spoke design		■	■	■
 18" Audi Sport cast aluminium wheels in 5-arm structured design		■	■	■

	Page	Q3	Q3 sport	Q3 design
 18" cast aluminium wheels in 5-spoke dynamic design		■	■	■
 18" cast aluminium wheels in 5-arm turbine design, partly polished ^{3,4}		–	–	□
 18" cast aluminium wheels in 5-arm turbine design, contrasting grey, partly polished ³		■	■	■
 18" cast aluminium wheels in 5-parallel-spoke design, (S design) ⁵		–	□	–
 19" Audi Sport cast aluminium wheels in 5-twin-spoke offroad design		■	■	■
 19" Audi Sport cast aluminium wheels in 5-segment-spoke design		■	■	■
 19" Audi Sport cast aluminium wheels in 10-spoke design in matt titanium look, gloss turned finish ³		■	■	■
 20" Audi Sport cast aluminium wheels in 5-arm rotor design in matt titanium look, gloss turned finish ³		■	■	■
 Audi Sport 20" cast aluminium wheels in 5-V-spoke design in matt titanium look, gloss turned finish ³		■	■ ⁵	■

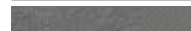
¹ Only available in conjunction with S line sport package at the price of regular pearl effect paint finish. ² Not available in conjunction with monsoon grey, metallic. ³ Please note the special information relating to wheels on page 91.

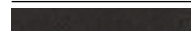
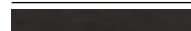
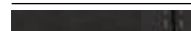
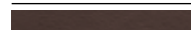
⁴ Only available in conjunction with Audi exclusive design package. ⁵ Only available in conjunction with S line sport package.









	Page	Q3	Q3 sport	Q3 design
 16" forged aluminium winter wheels in 7-arm design		■	■	■
 17" cast aluminium winter wheels in 5-arm Trias design		■	■	■
All-season tyres		■	■	■
Anti-theft wheel bolts		■	■	■
Tyre repair kit		□	□	□
Spare wheel, space-saving		■	■	■
Tyre pressure loss indicator		□	□	□
Vehicle tool kit		□	□	□
Vehicle jack		■	■	■
Seats	67			
Standard seats, front		□	–	□
Sport seats, front		■	□	■
Seat upholstery for standard seats, front	68			
 Initial cloth, black		□	–	–
 Style cloth, black		–	–	□
 Style cloth, rock grey		–	–	□
 Leather/artificial leather, black		■	–	■
 Leather/artificial leather, chestnut brown		■	–	■
 Leather/artificial leather, rock grey		■	–	■
 Leather/artificial leather, pistachio beige		■	–	■

	Page	Q3	Q3 sport	Q3 design
Seat upholstery for standard seats, front (continued)	68			
 Milano leather, black		■	–	■
 Fine Nappa leather, black		■	–	■
 Fine Nappa leather, chestnut brown		■	–	■
 Fine Nappa leather, rock grey		■	–	■
 Fine Nappa leather, pistachio beige		■	–	■
 Audi exclusive leather upholstery and trim ¹		■	■	■
Seat upholstery for sport seats, front	68			
 Sport cloth, black		–	□	–
 Sprint cloth/leather, black with contrasting stitching ²		–	□	–
 Norit cloth/rallye cloth in single-colour/pearl Nappa leather, Chennai brown with contrasting stitching in granite grey ³		–	–	■
 Alcantara/leather, black		■	■	■
 Alcantara/leather, rock grey		■	■	■
 Perforated Alcantara/leather, black with contrasting stitching ⁴		–	■	–
 Milano leather, black		■	■	■
 Fine Nappa leather, black		■	■	■
 Fine Nappa leather, black with contrasting stitching ⁴		–	■	–
 Fine Nappa leather, chestnut brown		■	–	■
 Fine Nappa leather, rotor grey with contrasting stitching ⁴		–	■	–
 Fine Nappa leather, Chennai brown with contrasting stitching in granite grey ³		–	–	■
 Fine Nappa leather, black with contrasting stitching in Chennai brown ³		–	–	■
 Audi exclusive leather upholstery and trim ¹		■	■	■
Leather package	68			
Audi exclusive fine Nappa leather upholstery and trim		■	■	■

□ Standard equipment ■ Optional equipment □ Standard/optional equipment varies by model – Not available

Country-specific variations possible. Please find out from your local Audi partner which equipment is standard and what optional equipment is available in your country.

More detailed descriptions of a selection of items from the equipment range can be found from page 42 onwards.

	Page	Q3	Q3 sport	Q3 design
Seat comfort	68			
Driver seat, electrically adjustable		■	■	■
Front seats, electrically adjustable		■	■	■
4-way lumbar support for the front seats		■	□	□
Seat heating, front		■	■	■
Centre armrest, front		■	■	■
Seats in the rear	68			
Rear seat backrest, folding		□	□	□
Headlinings	68			
Headlining in cloth		□	□	□
Headlining in cloth, black		■	□ ²	□ ⁵
Inlays	70			
 Micrometallic, silver		□	□	–
 3D aluminium mesh, silver ⁵		–	–	□
 Matt brushed aluminium ²		–	□	–
 Aluminium satellite		■	■	–
 Aluminium tangent, silver ⁶		–	–	□
 Aluminium tangent, bronze ⁶		–	–	□
 Walnut, balsamic brown		■	■	■
 Piano finish, black		–	■ ⁴	■ ³
 Inlays in Audi exclusive wood		■	■	■
Headlights	72			
Xenon plus		□	□	□
LED headlights		■	■	■

	Page	Q3	Q3 sport	Q3 design
Headlight cleaning system ⁷		■	■	■
High-beam assist		■	■	■
Light/rain sensor		■	■	■
Rear lights		□	□	□
LED rear lights ⁸		■	■	■
LED rear lights with dynamic indicator ⁷		■	■	■
Adaptive brake light		■	■	■
Interior lighting	73			
Interior lighting		□	□	□
LED interior lighting package		■	■	■
Exterior design	73			
Model name/logo		□	□	□
Audi Singleframe		□	□	□
Roof rails, black		□	■	■
Roof rails, aluminium anodised		■	□	□
Roof edge spoiler		□	□	□
Exhaust tailpipe with chrome surrounds		□	□	□
Gloss package		■	□	□
Audi exclusive black gloss package ¹⁰		■	■	■
Interior design	74			
Door sill trims in plastic		□	□	□ ⁹
Door sill trims and loading sill protector		■	□ ²	□
Floor mats, front		□	□	□
Floor mats, rear		■	■	■
Aluminium-look interior		■	□	□

¹ Available in fine Nappa leather. ² Standard in conjunction with S line sport package. ³ Only available in conjunction with Audi exclusive design package. ⁴ Only available in conjunction with S line sport package.

⁵ Standard in conjunction with Audi exclusive design package. ⁶ Depending on selected colour of interior equipment. ⁷ Part of LED headlights ⁸ Only available in conjunction with xenon plus. ⁹ For Q3 design with aluminium inlay.

¹⁰ Not available in conjunction with contrasting paint finish. ¹¹ Only available for models with S tronic. ¹² For information on when this feature will be available, please contact your Audi partner.

	Page	Q3	Q3 sport	Q3 design
Steering wheels/controls	74			
Steering wheel in 4-spoke design		□	–	–
Leather steering wheel in 4-spoke design		■	–	□
Multifunction leather steering wheel in 4-spoke design		■	–	□ ⁵
Multifunction leather steering wheel in 4-spoke design with shift paddles ¹¹		■	–	■
Sport leather steering wheel in 3-spoke Q design		■	□	–
Multifunction sport leather steering wheel in 3-spoke Q design		■	■	■
Multifunction sport leather steering wheel in 3-spoke Q design with shift paddles ¹¹		■	■	■
Multifunction sport leather steering wheel in 3-spoke design, flattened at the bottom ¹²		–	■	–
Multifunction sport leather steering wheel in 3-spoke design, flattened at the bottom with shift paddles ^{11, 12}		–	■	–
Audi exclusive aluminium gear lever knob		■	■	■
Audi exclusive leather controls		■	■	■
Mirrors	75			
Exterior mirrors with integrated LED indicator		□	□	□
Exterior mirrors, additionally heated		■	■	■
Exterior mirrors, additionally heated and electrically folding		■	■	■
Exterior mirrors, additionally heated, electrically folding and automatically dimming on the driver side		■	■	■
Interior mirror, manually dimming		□	□	□
Interior mirror, automatically dimming		■	■	■
Vanity mirrors		□	□	□
Roof system	75			
Panoramic glass sunroof		■	■	■
Glazing	75			
Heat-insulating glass, tinted green		□	□	□
Acoustic windscreen		■	■	■

	Page	Q3	Q3 sport	Q3 design
Glazing (continued)	75			
Dark-tinted windows (privacy glazing)		■	■	■
Sun visors, extendable		□	□	□
Climate control	76			
Manual air conditioning		□	□	□
Deluxe automatic air conditioning		■	■	■
Closing systems	76			
Remote control key		□	□	□
Convenience key		■	■	■
Electronic immobiliser		□	□	□
Luggage compartment lid, electrically opening and closing		■	■	■
Anti-theft alarm		■	■	■
Preparation for tracking system		■	■	■
Storage/transport	76			
Storage compartments		□	□	□
Storage package		■	■	■
Luggage compartment package		■	■	■
Storage and luggage compartment package		■	■	■
Cup holders		□	□	□
Luggage compartment cover, extendable		□	□	□
Through-loading facility		■	■	■
Reversible mat		■	■	■
Reversible luggage compartment floor		■	■	■
Lashing points		□	□	□
Loading sill protector in stainless steel		■	□ ¹	□
Cigarette lighter and ashtray		■	■	■

	Page	Q3	Q3 sport	Q3 design
12V socket		□	□	□
Trailer towing hitch		■	■	■
Provision for trailer towing hitch		■	■	■
MMI®/navigation	78			
Instrument cluster		□	□	□
Centre display		□	□	□
Driver information system		■	□	□
Driver information system with colour display		■	■	■
Attention assist		■	■	■
Navigation package		■	■	■
MMI® navigation plus		■	■	■
Entertainment	78			
Audi radio		□	□	□
MMI® radio		■	■	■
Digital Audio Broadcasting		■	■	■
Digital TV reception		■	■	■
Audi music interface		■	■	■
Audi music interface online		■	■	■
Audi sound system		■	■	■
Bose Surround Sound		■	■	■
Communication	80			
Audi connect including car phone		■	■	■
Bluetooth interface		■	■	■
Audi phone box		■	■	■
Connectivity package		■	■	■
Audi MMI® connect app		■	■	■

	Page	Q3	Q3 sport	Q3 design
Assistance systems	80			
Hold assist		■	■	■
Hill hold assist		□	□	□
Hill descent control		■	■	■
Parking system, rear		■	■	■
Parking system plus		■	■	■
Parking system plus with reversing camera		■	■	■
Park assist		■	■	■
Park assist and reversing camera		■	■	■
Cruise control		■	■	■
Audi side assist		■	■	■
Audi active lane assist		■	■	■
Camera-based recognition of traffic signs ²		■	■	■
Driving dynamics/brakes	82			
Audi drive select		■	□	□
Suspension with comfortable tuning		□	□	□
S line sport suspension		■	□ ¹	■
Suspension with damper control		■	■	■
Front-wheel drive ³		□	□	□
quattro ^{®3}		□	□	□
S tronic ^{®3}		□	□	□
Coasting mode ⁴		□	□	□
6-speed manual transmission ³		□	□	□
Electromechanical parking brake		□	□	□
Electromechanical power steering		□	□	□

	Page	Q3	Q3 sport	Q3 design
Technology/safety	83			
Antilock Brake System (ABS)		□	□	□
Anti-Slip Regulation (ASR)		□	□	□
Electronic Differential Lock (EDL)		□	□	□
Electronic Stabilisation Control (ESC)		□	□	□
Wheel-selective torque control ⁵		□	□	□
Recuperation		□	□	□
Start-stop system		□	□	□
Airbags		□	□	□
Side airbags, front, and head airbag system		□	□	□
Side airbags, rear		■	■	■
Side impact protection		□	□	□
Integrated head restraint system		□	□	□
Seat belts		□	□	□
Seat belt reminder		□	□	□
ISOFIX child seat mounting and top tether for the outer rear seats		□	□	□
ISOFIX child seat mounting for the front-passenger seat		■	■	■
First-aid kit with warning triangle		■	■	■
Audi Extended Warranty	83			
Audi Extended Warranty		■	■	■

Equipment for the Audi Q3 illustrated (p.4–23):
 paint finish: Hainan blue, metallic
 wheels: cast aluminium wheels in 5-spoke dynamic design
 seat upholstery: Alcantara/leather, rock grey
 inlays: aluminium satellite

□ Standard equipment ■ Optional equipment □ Standard/optional equipment varies by model

Country-specific variations possible. Please find out from your local Audi partner which equipment is standard and what optional equipment is available in your country.

More detailed descriptions of a selection of items from the equipment range can be found from page 42 onwards.

¹ Standard in conjunction with S line sport package. ² Only with Audi active lane assist in conjunction with MMI navigation plus. ³ Depending on engine. ⁴ Only available for models with S tronic and Audi drive select.

⁵ Only available for models with quattro permanent all-wheel drive.



Discover the world of Audi.



Responsibility

Living up to our responsibilities is a principle that is firmly anchored in Audi strategy. Alongside commercial success and international competitiveness, our responsibility toward company employees and society as a whole is a key consideration, as is protecting the environment and conserving resources. And what is true in the details – our catalogues are printed on FSC-certified paper – also holds in general: Audi develops cars that are not only sporty and emotive but also ever more efficient. In the long run, Audi wants its products to allow CO₂-neutral

mobility. Seeing to it that production in Audi plants gradually becomes CO₂-neutral is another aspect of our comprehensive approach. Audi is also committed to society – particularly in the fields of education, technology and social projects. At Audi, sustainability is closely linked with how we see the future: the Audi Urban Future Initiative sees Audi working with international experts to get to the root of future urban challenges and trends in mobility.

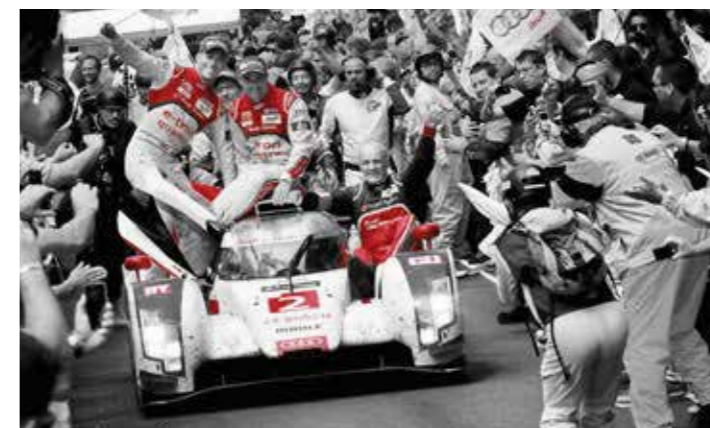

The Audi experience

The fascination of Audi can be experienced in many different ways. Audi City Berlin, Audi City London and Audi City Beijing, for example, give you digital access to all models at their actual size and in real time. And of course it is always worth visiting one of the major motor shows. This is where Audi always presents its new models and invites you to take a look at how the future is being shaped with "Vorsprung durch Technik". Anyone interested in seeing how Audi is already putting this into practice will find fascinating insight in the "Vorsprung durch Technik" online special at www.audi.com. But a look back can also be rewarding: at the Audi museum mobile in Ingolstadt, history and high-tech go hand in hand. A total of 130 historic exhibits and state-of-the-art

forms of presentation make for a thrilling symbiosis. Plus, Audi driving experience allows you to live the excitement and countless possibilities of current Audi models. Here, pure driving enjoyment is combined with valuable learning effects. This is ensured by a team of specially trained and highly qualified instructors who provide practical tips to help you optimise your driving skills. All this can now also be enjoyed at the recently opened Audi driving experience center in Neuburg, near Ingolstadt. Facilities here include a circuit of up to 3.4 kilometres that features challenging combinations of bends, a 30,000 m² dynamic driving area and an offroad section where Q models can be put through their paces.



Team spirit

Motorsport is a driving force behind the brand. For years Audi has been among the champions in various racing series, for instance the 24 Hours of Le Mans or the DTM German Touring Car Masters. The values that are crucial in many different areas of sport are also central ones for Audi: precision, passion and technology. No coincidence then that Audi has been sponsoring sporting events for

many years. In the world of winter sports, for example, Audi has been the main sponsor of the German Ski Association (DSV) for almost three decades and has also partnered 16 other national alpine teams. In football, we support national and international teams. And Audi is also a partner for the German Olympic Sports Confederation.

Choosing an Audi means choosing a brand that offers more. More individuality. More exclusivity. More fascination.

www.audi.com

Information on all the topics mentioned above can be found on our website: www.audi.com.



www.audi.com



configurator.audi.com



www.audi.com/vorsprung-durch-technik



www.audi.com/driving



www.audi.com/cr



AUDI AG
85045 Ingolstadt
www.audi.com
Valid from April 2015

Printed in Germany
533/1130.20.18

The models and equipment versions illustrated and described in this brochure and some of the services listed are not available in all countries. Some of the cars illustrated are equipped with optional features for which an extra charge is made. Details concerning the delivery specifications, appearance, performance, dimensions and weights, fuel consumption and running costs of the vehicle were correct to the best of our knowledge at the time of going to press. Deviations from the colours and shapes shown in the illustrations may occur. No liability is accepted for errors and printing errors. The right to introduce modifications is reserved. Not to be reproduced, including in part, without the written approval of AUDI AG.

This brochure is printed on paper made from pulp bleached without the use of chlorine.

