



THE X5

THE BMW X5.



INNOVATION AND TECHNOLOGY.



18 Dynamics and efficiency
19 Drivetrain and suspension

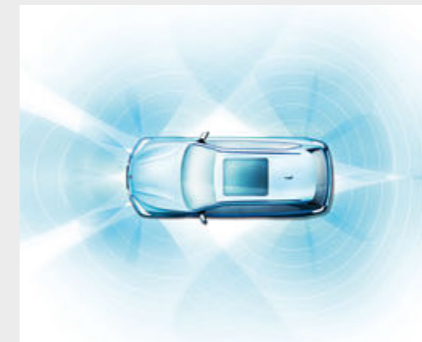

20 Driver assistance
21 Safety



22 Connectivity and infotainment
23 Comfort and functionality

EQUIPMENT.



24 Models and lines



30 BMW Individual



32 Additional equipment



36 Exterior colours

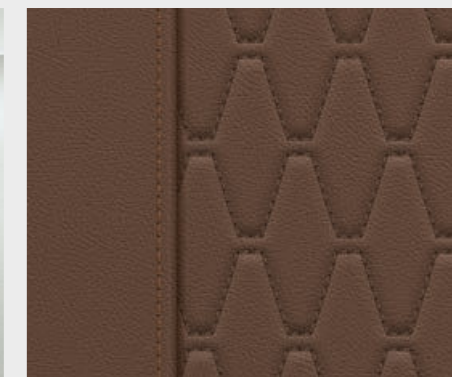

38 Interior colours

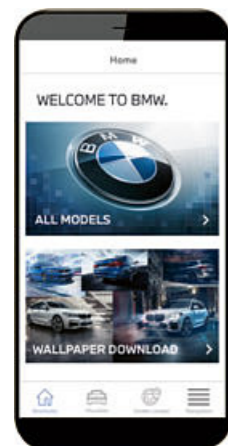

YOUR NEW SPEED DATING APP.

DOWNLOAD NOW THE BMW BROCHURES APP FROM YOUR APP STORE AND DISCOVER DRIVING PLEASURE!



40 Wheels and tyres



41 Original BMW Accessories

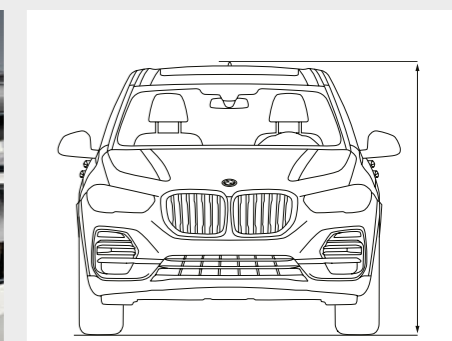

42 Technical data



EVERYTHING.
MULTIPLIED BY X.



A CHALLENGE.
TO ALL THE OTHERS.

GET IN.
AT THE HIGHEST LEVEL.





SOMEONE HAS
TO BE IN CHARGE.



DOESN'T ASK. ACTS.

THERE IS NO LIMIT
TO GREAT IDEAS.





ALWAYS AT THE
FOREFRONT.

POWERFUL PRESENCE IN THE EXTERIOR DESIGN DYNAMIC, FORWARD-LOOKING APPEARANCE WITH STRIKING SIDE CONTOUR¹ || BMW LASERLIGHT¹ WITH X SIGNATURE¹ || 22" LIGHT ALLOY WHEELS¹ || **NEXT-LEVEL DRIVER ASSISTANCE AND CONNECTIVITY** DRIVING ASSISTANT PROFESSIONAL WITH EXTENSIVE SAFETY AND COMFORT FEATURES || CUSTOMISABLE BMW LIVE COCKPIT PROFESSIONAL WITH TWO 12.3" DISPLAYS || DIGITAL KEY¹ || **LUXURIOUS FEEL, COMFORTABLE EQUIPMENT** WELCOME LIGHT CARPET || AMBIENT LIGHT AND DYNAMIC INTERIOR LIGHTING || PANORAMA GLASS ROOF SKY LOUNGE¹ || ELECTRIC ROLLER COVER¹ || TWO-PART ELECTRIC TAILGATE¹ || **OUTSTANDING DRIVING DYNAMICS ON ANY SURFACE** BMW XDRIVE || ADAPTIVE 2-AXLE AIR SUSPENSION¹ AND XOFFROAD PACKAGE¹ || INTEGRAL ACTIVE STEERING¹ || ADAPTIVE M SUSPENSION PROFESSIONAL¹ || ACTIVE AIR STREAM KIDNEY GRILLE¹ || BMW EFFICIENTLIGHTWEIGHT. **KNOW YOU CAN – THE BMW X5.**

¹ Available as optional equipment.

DYNAMICS AND EFFICIENCY.

BMW EFFICIENTDYNAMICS.
LESS EMISSIONS. MORE DRIVING PLEASURE.

MORE POWER FROM LESS FUEL.

More power from 3 to 12 cylinders. Consume less, experience more – the **BMW TwinPower Turbo engines** offer the greatest possible dynamic performance with the greatest possible efficiency thanks to the newest injection systems, variable output control and sophisticated turbocharger technology. Whether diesel or petrol, and no matter how many cylinders, the engines from the BMW EfficientDynamics engine family allow markedly more agile power delivery and outstanding responsiveness even at low rpm, while being fuel-efficient and low in emissions.

MORE DRIVING PLEASURE, LESS EMISSIONS.

BMW EfficientDynamics is a technology package that includes not only the drive, but rather the whole vehicle concept and intelligent energy management. Provided as standard in every BMW, a variety of innovative technologies contribute to continuously improving efficiency. Via engine efficiency measures, electrification, lightweight construction methods and optimised aerodynamics, BMW has managed to reduce the CO₂ emissions of its fleet significantly.

MORE DYNAMICS, LESS WEIGHT.

Lower weight with intelligent lightweight construction. Special consideration for every last detail – intelligent lightweight construction means that the optimal material is found and implemented for each part of the vehicle. With extremely light high-tech materials such as aluminium and carbon fibre, **BMW EfficientLightweight** is pursuing the goal of minimising vehicle weight. That leads to even more dynamic performance, increased stability and heightened safety and comfort.



AERODYNAMICS

In the BMW X5, extensive measures reduce aerodynamic drag, e.g. the third-generation air vent control (Active Air Stream kidney grille). Together with numerous aerodynamic optimisations, such as a targeted air flow to reduce turbulence on the front wheel or the Air Blades at the rear, consumption and CO₂ emissions are effectively reduced.

MILD HYBRID TECHNOLOGY

Mild hybrid technology* is used to recover braking energy and supports the combustion engine during acceleration with electric power. This reduces fuel consumption and emissions while giving you a dynamic advantage. The mild hybrid technology also makes the Automatic Start/Stop function much faster and much more comfortable.

DRIVING EXPERIENCE CONTROL INCL. ADAPTIVE MODE

The Driving Experience Control offers the driver the choice between the standard COMFORT mode, ECO PRO Mode, geared towards efficiency, and SPORT mode, which enables even more dynamic driving. The new interactive function Adaptive Mode continuously adjusts the Dynamic Damper Control, the steering and the Steptronic transmission to suit the current driving situation.

IN THE NEW BMW X5.

¹ Available as optional equipment.
² Standard for M50i and M50d.
³ Electronically limited.

*The availability of some equipment features and functions depends on engine variants or additional options. The market and production availability may vary. You can find detailed information about terms, standard and optional equipment at www.bmw.com or from your BMW Partner.

DRIVETRAIN AND SUSPENSION.

Innovation and technology 18 | 19



ENGINE HIGHLIGHTS OF THE BMW X5.

X5 M50d

- M TwinPower Turbo 6-cylinder diesel engine with 294 kW (400 hp) and 760 Nm torque
- Acceleration 0–100 km/h: 5.2–5.3 s
- Top speed: 250 km/h³
- Combined fuel consumption: 6.9–7.2 l/100 km
- Combined CO₂ emissions: 180–190 g/km

X5 xDrive40i

- BMW TwinPower Turbo 6-cylinder petrol engine with 250 kW (340 hp) and 450 Nm torque
- Acceleration 0–100 km/h: 5.5–5.7 s
- Top speed: 243 km/h
- Combined fuel consumption: 8.0–8.9 l/100 km
- Combined CO₂ emissions: 183–203 g/km

In the BMW X5 – for the first time for a BMW – an xOffroad package^{1,*} is available, with which you are always safe and smooth on the road as well as on less firm surfaces. Four selectable off-road modes adapt the all-wheel drive xDrive even more precisely to the current driving surface – for even better traction on sand, rocks, gravel or snow.

The Adaptive 2-axle air suspension^{1,*} makes driving particularly comfortable with high driving dynamics and makes it easier to get in and out and load the vehicle. The air suspension automatically keeps the vehicle at a constant height regardless of the load. It can also be raised or lowered manually at the touch of a button.

The M Sport brake^{1,2,*} has four-piston fixed callipers at the front and single-piston floating callipers at the rear in blue with the M designation and features larger brake discs to ensure an outstanding braking performance.

The Adaptive M suspension Professional^{1,*} combines the technology of Adaptive M suspension, body roll stabilisation and Integral Active Steering. The result: the ultimate in driving stability and dynamics.

The M sport exhaust system^{1,2} delivers a sound that can be adjusted to an even more intense engine sound with the driving dynamics buttons in the SPORT and SPORT+ programmes, while the comfort-oriented programme prioritises more discreet engine acoustics.

DRIVER ASSISTANCE.

BMW Personal CoPilot. By your side, when you decide.

THE INNOVATIVE BMW ASSISTANCE SYSTEMS.

The BMW driver assistance systems offer the ultimate in comfort and safety. Whether it's for driving or parking, BMW driver assistance systems are there when you need them, reliably and in every situation. The most cutting-edge sensors, such as radar, ultrasound and cameras, dependably register the vehicle's surroundings, forming the basis for intelligent driver assistance systems. Either activated when desired, or as emergency assistance in the background – the BMW driver assistance systems make every drive in your BMW even safer and more enjoyable.

CLOSER TO AUTONOMOUS DRIVING THAN EVER BEFORE.

Autonomous driving is not a utopia, it is the future: All over the world, BMW Personal CoPilot test vehicles are already driving completely independently without the driver's intervention and not only show impressively how mobility will change in the near future – they also offer an outlook on the next level of driving pleasure. Even today, the BMW driver assistance systems already offer a large number of intelligent semi-automated functions that actively support and relieve the driver in almost every driving situation.

SIMPLY PARK IT.

With intelligent parking assistance systems, you don't just look forward to every ride in your BMW, but also to parking and manoeuvring. For example, the Parking assistant already displays suitable parking spaces as you drive past and, depending on the BMW model, runs the parking process either partially or completely independently. But here too, automation will continue to advance, so that in the future it will be possible for vehicles without drivers to search for a parking space and execute the parking process autonomously.



DRIVING ASSISTANT PROFESSIONAL

Driving Assistant Professional^{1,2} offers optimum comfort and maximum safety during critical or monotonous traffic situations. It includes: Steering and Lane Control Assistant incl. support in narrow places, Lane Change and Emergency Stop Assistant, local hazard alert and Lane keeping assistant with active side collision protection as well as other safety functions.

CROSSROADS WARNING WITH BRAKE INTERVENTION

The Crossroads warning with city braking* function detects traffic lights, traffic signs and vehicles crossing and can avoid accidents. If a collision cannot be avoided, the system helps to reduce the impact speed.

REVERSING ASSISTANT

The Reversing Assistant* stores the last 50 m of the driven path in forward travel up to 35 km/h, so that it can be retracted if required. You are relieved of the steering work and can concentrate on monitoring the vehicle environment.

IN THE NEW BMW X5.

The key visual for BMW Personal CoPilot shown here is an exemplary, artistic representation, which can deviate from the design and equipment of the BMW model described in this medium.

SAFETY.

■ Standard equipment □ Optional equipment

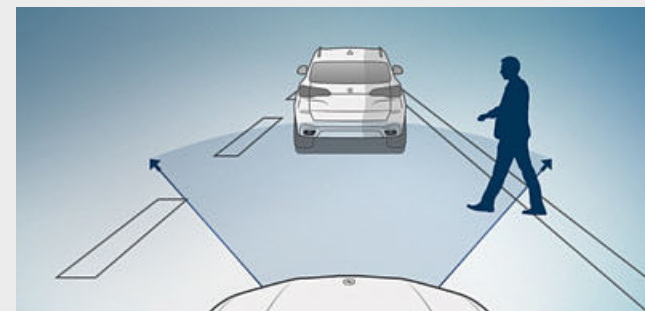

□ Active Guard Plus* includes the front collision warning with braking function, Lane Departure Warning with active return to the lane as well as the Speed Limit Info including manual takeover of the setting speed for the Speed Limiter with No-overtaking indicator. The emergency braking function responds in the event of an imminent collision with vehicles, pedestrians or cyclists.

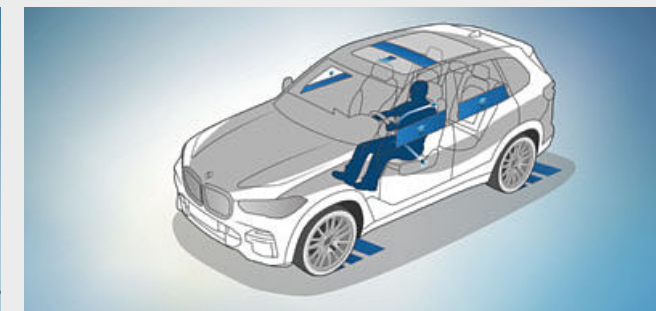

□ Active Protection is a preventive occupant protection system that pretensions the seat belts in critical situations, puts electric seats in an upright position and closes windows and the sunroof, if featured.

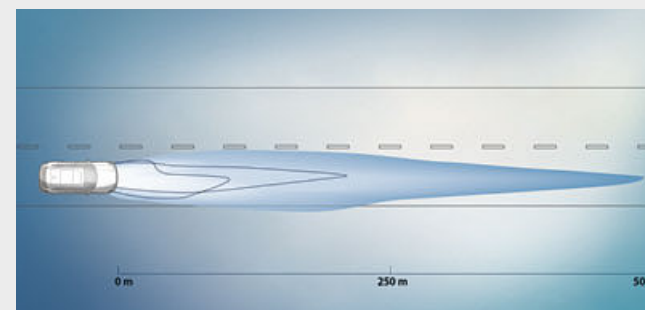

□ In laser high-beam mode, BMW Laserlight in a unique X design illuminates a range of up to 500 m, nearly twice as far as that of conventional headlights. Better visibility in the dark significantly increases safety. The blue X signature and the "BMW Laser" lettering underline the vehicle's technological standards.

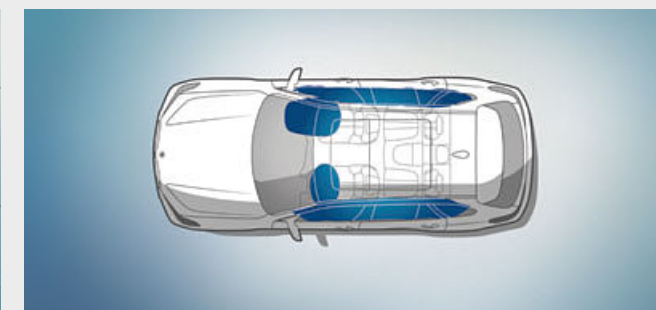

■ Airbags for driver and front passenger are part of the optimally coordinated safety components in a BMW. Overall, six airbags provide targeted protection: the driver and front passenger airbags, the head airbags for the entire window surface on the side, and the side airbags integrated into the front seat backrests.

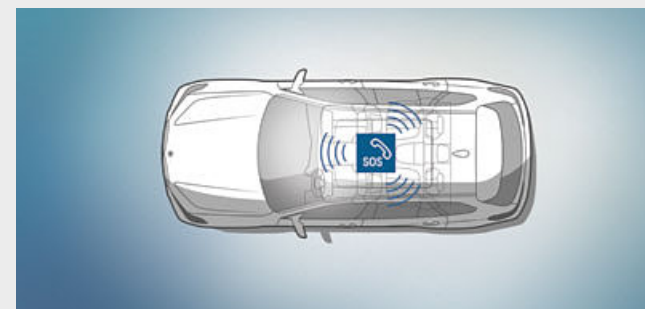

■ If there is an accident, time is of the essence. Intelligent Emergency Call* gets help and can even save lives in case of an emergency. It contacts specially trained call centre agents in native language who offer support to you and your passengers until the emergency services arrive. The first responders also receive important information directly.

¹ Available as optional equipment.

² Function may be limited in darkness, fog or bright glare.

* The availability of some equipment features and functions depends on engine variants or additional options. The market and production availability may vary. You can find detailed information about terms, standard and optional equipment at www.bmw.com or from your BMW Partner.

Some ConnectedDrive Services may differ between countries. Please consult your local BMW partner for more information.

CONNECTIVITY AND INFOTAINMENT.

BMW ConnectedDrive So connected, you're free.

CONNECTED FOR OVER 20 YEARS.

Focused on the future – from the very beginning. By the 1990s, BMW had already made headway in connected mobility. Another milestone of the digital future was surpassed in 2004: vehicles with built-in SIM cards. Then came the first online functionality, Google Services and innovative display systems such as the BMW Head-Up Display. Throughout this process, the desires of the customer have always taken centre stage. In a first for a premium automobile manufacturer, BMW makes it possible to book and pay for services flexibly via the BMW ConnectedDrive Store, in the vehicle or on a computer at home. And with the introduction of BMW Connected, the Open Mobility Cloud, Remote Software Upgrades and the BMW Intelligent Personal Assistant, BMW is taking the next steps into the future of mobility.

MORE THAN 20 SERVICES IN THE BMW CONNECTED DRIVE STORE.

BMW ConnectedDrive opens the gate to the digital world of BMW. Use vehicle apps such as news, weather, office or online search on the go and be well informed at all times. Via the ConnectedDrive Store or directly in your BMW, you can book additional digital services such as Connected Music or Concierge Service – anytime, anywhere, easily and flexibly.

IN TOUCH 24/7, WITH BMW CONNECTED.

What would it be like if you were never late again? What if your BMW already knew your preferred destinations? How would you like reliable navigation, whether you're sitting in your vehicle or not? BMW Connected provides you with the information you want, when and where you want it. BMW Connected is a personal mobility assistant which facilitates your everyday mobility and aids you in reaching your destinations relaxed and on time. With the BMW Connected app, mobility-relevant information such as recommendations for optimal departure times are available at any time via smartphone or smartwatch and can be seamlessly transmitted to the car.



PARKING PLACE ASSIST

Trying to find a parking space close to your destination? This is an easy task with the Parking Space Assistant*. It suggests vacant spaces in large parking facilities or on the street and, based on your selection, finds the best route for you with the highest likelihood of an available space. You can also pay for parking cash-free using PARK NOW.

DIGITAL KEY

Why put your key in the ignition if you have your Android smartphone with you? The Digital Key^{2,*} or Key Card allows you to lock and unlock your BMW and even start the engine without needing a physical key. It can be downloaded to your Android smartphone using the BMW Connected app and shared with family and friends.

REMOTE SERVICES

Did I lock my car doors? Where exactly is it parked? Remote Services* allows you to access your vehicle from a distance using the BMW Connected app. Flash your headlights, activate the climate control function inside your vehicle or lock your BMW from anywhere using your smartphone.

IN THE NEW BMW X5.

¹ Available as optional equipment.

² Equipment optionally available for selected Samsung smartphones. Included in the optional "Comfort access system". Alternatively, you have the possibility to open and start the car via a key card.

*The availability of some equipment features and functions depends on engine variants or additional options. The market and production availability may vary. You can find detailed information about terms, standard and optional equipment at www.bmw.com or from your BMW Partner.

COMFORT AND FUNCTIONALITY.



The Panorama glass roof Sky Lounge¹ creates a generous sense of space during the day, while at night it lends an atmospheric mood with a light design consisting of more than 15,000 light elements. The light design can be switched between six Ambient light colours.

The temperature-controlled cupholders¹ in the centre console can individually cool or keep stored beverages warm. The temperature control is activated via buttons on the left and right. The ambient lighting also indicates the function (blue for cooling or red for heating).

The Comfort access system¹ makes it possible to open all of the vehicle doors without using the key and to start the vehicle by pressing a button, while the key remains in the pocket. The tailgate can be opened and closed without even being touched with a quick wave of the foot under the rear bumper. Additionally the Digital Key^{2,*} on the smartphone or the included key card can be used for accessing and starting the vehicle.

Both the upper^{1,*} and the lower^{1,*} part of the tailgate can be opened and closed electrically. This facilitates access and loading of the luggage compartment. The lower part of tailgate can also be used as a practical seat.

The Ambient Air Package¹ comprises a fragrance dispersal function and an air ionisation function. There are eight fragrances to choose from, all specially composed for the vehicle.

The 3rd row of seats^{1,*}, with two individually foldable and forward-facing seats, offer room for two additional passengers. The outer seats of the 2nd row of seats also feature comfort cushions on the headrest. To ensure easy access, the 2nd row of seats can be folded forward with the Easy-Entry function.

The Massage function for driver and passenger^{1,*} improves the physical wellbeing by stimulating or relaxing certain muscle groups. There are eight massage programmes dedicated to different parts of the body.

The Travel & Comfort system* includes two additional USB ports (type C) and a preparation for two multifunctional holders in the rear of the vehicle. Tablets, clothes hangers or folding tables, for example, can be attached to them.

BASE.

Discover even more with the new BMW brochures app. Available now, for your smartphone and tablet.



■ The slim-modelled instrument panel and the pronounced command position ensure optimum overview of the driving situation at all times. The Sport leather steering wheel feels good in your hands, and the Aluminium 'Mesh effect' dark interior trim finishers set visual highlights.



■ The standard Sport seats for driver and front passenger have multiple electrical adjustment options and ensure a particularly good seating position and optimum lateral support. The standard leather 'Vernasca' with design perforation, shown here in Canberra Beige, gives the interior a particularly high-quality look.

Selected base model equipment features:

- 18" light alloy wheels
- LED headlights
- BMW Live Cockpit Professional
- Sport leather steering wheel
- Sport seats for driver and front passenger
- 2.5-zone automatic air conditioning
- Steptronic transmission
- Adaptive suspension
- Rear seat backrest with 40:20:40 division
- Ambient light incl. dynamic interior light



■ 18" light alloy wheels V-spoke style 618 in Reflex Silver, wheel size 8.5J x 18, with 255/55 R18 tyres.

XLINE.

Equipment 24 | 25

■ Standard equipment □ Optional equipment



□ The combination of Sport leather steering wheel and the open-pored fine-wood trim in poplar grain light anthracite-brown has a sporty-elegant effect. The air conditioning and radio control units as well as the air vents are additionally enclosed with galvanic elements and further enhance the dashboard visually.



□ Comfort seats with electrical adjustment allow a perfect seating position. Upholstered in high-quality leather 'Vernasca' Ivory White with design perforation, they have a luxurious look.



■ 19" light alloy wheels V-spoke style 735 in Ferric Grey, wheel size 9J x 19 with 265/50 R19 tyres.

xLine exterior equipment:

- BMW kidney grille with exclusively designed vertical slats with front sides in aluminium with satinised look, grille frame in Pearl Chrome
- 19" light alloy wheels V-spoke style 735; other wheels available
- BMW Individual Exterior Line aluminium with satinised look, alternatively BMW Individual high-gloss Shadow Line
- Specific air inlets in aluminium with satinised look
- Air Breather in Pearl Chrome with surround in aluminium with satinised look
- Specific grilles in the front lateral air inlets in black high-gloss
- Exclusive water-catching strip in the A-pillar in black high-gloss
- Side skirts trim with trim strip in aluminium with satinised look
- Sump guard front and rear in stainless steel styling
- Active air stream kidney grille with accent bar in Aluminium with satinised look
- Tailpipe trims in aluminium with satinised look
- BMW Individual roof rails aluminium with satinised look, alternatively BMW Individual roof rails high-gloss Shadow Line

xLine interior equipment:

- Door sill finishers in aluminium with "BMW xLine" lettering
- Car key with chrome clasp

M SPORT PACKAGE.

Discover even more with the new BMW brochures app. Available now, for your smartphone and tablet.

powered by 

■ Standard equipment □ Optional equipment



□ The high-quality and high-grip M leather steering wheel with multifunction buttons is an eye-catcher. The interior trim finishers in fine-wood trim 'Fineline Stripe' brown give the interior an exclusive atmosphere. The clear instrument panel defined by long lines creates a wide-ranging effect in the interior.



□ The M Multifunction seats* for the driver and front passenger in exclusive design and with M logo on the headrest reflect the vehicle's athletic look. Lower seat bases and high side bolsters emphasize the shell-seat look and guarantee flawless lateral support. Accompanied by a comprehensive range of adjustment possibilities, maximum comfort is achieved.

M Sport package exterior equipment:

- M Aerodynamics package with front apron, side skirts and wheel arch trims in body colour
- LED fog lights
- 20" M light alloy wheels Star-spoke style 740 M in Bicolour with mixed tyres and run-flat properties; other wheels available
- Adaptive M suspension; other suspensions available
- Steptronic Sport transmission
- BMW Individual high-gloss Shadow Line, alternatively BMW Individual Exterior Line Aluminium satinised
- M designation on the sides
- M Sport brake with blue painted brake callipers with M designation
- Rear apron with diffuser insert
- Tailpipe trim strip in M Sport package specific geometry
- Exclusive paintwork in Carbon Black metallic; other paintworks available
- BMW Individual roof rails high-gloss Shadow Line
- Welcome Light Carpet

The interior equipment of the M sports package:

- M door sill finishers, illuminated, M driver footrest and M specific pedals
- Sport seats for the driver and front passenger in leather 'Vernasca' black with M signature; other upholsteries available
- M Leather steering wheel
- BMW Individual headliner Anthracite
- Interior trim finishers in Aluminium 'Mesheffect' dark, alternatively M
- Sport package specific interior trim finishers in Aluminium Tetragon; other trims available
- Instrument cluster with M specific display in SPORT and SPORT+ mode
- M Sport package specific vehicle key
- M specific floor mats in velour¹



□ 21" M light alloy wheels Y-spoke style 741 M Bicolour Orbit Grey with mixed tyres, burnished, front 9.5J x 21 with 275/40 R21 tyres, rear 10.5J x 21 with 315/35 R21 tyres.



□ 22" M light alloy wheels Double-spoke style 742 M Jet Black with mixed tyres, front 9.5J x 22 with 275/35 R22 tyres, rear 10.5J x 22 with 315/30 R22 tyres.



■ Exclusive doorsill finishers with M model designation provide a sporting welcome when the doors are opened.



■ The 8-speed Steptronic Sport transmission offers incredibly sporty gear changes, both automatically and manually via the gearshift paddles or selector lever.

¹ Only available in conjunction with Leather 'Vernasca' Black with contrast stitching.

The availability of some equipment features and functions depends on engine variants or additional options. The market and production availability may vary. You can find detailed information about terms, standard and optional equipment at www.bmw.com or from your BMW Partner.

THE BMW X5 M50d AND BMW X5 M50i.



Driving pleasure to the power of X: The BMW X5 M50i and the BMW X5 M50d combine the best of BMW X with a generous portion of BMW M. Design that shows even more bite and performance that impresses with even more power and agility. The specific kidney grille frame, the enlarged air intakes and 22" M light alloy wheels V-spoke style 747 M Bicolour impress from the outside, while interior trim finishers in Aluminium Tetrágono, the M leather steering wheel and the Sport seats create a sporty atmosphere on the inside. Under the bonnet, M TwinPower Turbo technology is used to deliver pure adrenaline over a wide range of revs with extremely spontaneous response characteristics and high torque. Precisely coordinated, all components work together for one goal: athletic driving characteristics for even more driving pleasure.



THE BMW X5 xDRIVE45e.



Flexible, dynamic – and irresistible: The BMW X5 xDrive45e combines the best of a BMW TwinPower Turbo petrol engine with the advantages of an eDrive. The interaction of the two engines is controlled highly efficiently by an intelligent energy management system, so that you can master every challenge with ease. Without lag, the electric motor converts its power into propulsion and impressively supports the petrol engine at every acceleration, or even drives the BMW X5 xDrive45e purely electrically – and without engine noise – to 135 km/h. You can conveniently check whether the charge level is sufficient for purely electric route guidance using BMW Connected eDrive Services. And if not, just keep going in hybrid mode – much further, more dynamic and exciting than you'd ever imagined.



The M leather steering wheel including multifunction and M emblem features the three-spoke design. With a steering wheel rim and contoured thumb rests, it provides a direct, athletic steering experience.



The "M50d" model designation in Cerium Grey is positioned on the right at the rear and further underscores the exclusivity of the BMW X5 M50d.



As soon as the doors are opened, the exclusive doorsill finishers with M model designation signal the sporting DNA of the vehicle.



The BMW X5 M50d offers outstanding precision and agility. The dynamic characteristics are increased, and intensive driving pleasure assured, thanks to the M50d-specific calibration of the suspension, the variable sport steering, the standard M Sport brake, the M Sport differential and the M Sport exhaust system.



The plug-in hybrid-specific instrument cluster provides information on, among other things, the status of the vehicle's electric readiness, the charge level of the battery and average electrical consumption.



21" M light alloy wheels Y-spoke style 741 M Bicolour Orbit Grey with mixed tyres, burnished, front 9.5J x 21 with 275/40 R21 tyres, rear 10.5J x 21 with 315/35 R21 tyres.

BMW INDIVIDUAL.

THE EXPRESSION OF PERSONALITY.



Sparkling, expressive, unmistakable: The Xirallic effect pigment contained in the BMW Individual Ametrine metallic contains very fine metal particles. They give the surface a glitter that even increases depending on the angle of light.



Particularly soft, voluminous leather in immaculate quality forms the basis for the BMW Individual extended leather trim 'Merino' in Black. Carefully processed, the result is a unique experience for the hands and the eyes.



Tulip wood, applied in several layers and with the greatest craftsmanship, is painted with deep black piano finish. The result fascinates with a surface brilliance that is fine and timelessly stylish at the same time.

If someone decides, then you: BMW Individual offers you all the options to customise the BMW X5 according to your wishes, with the degree of customisation entirely up to you. Add your personal driving experience to the typical BMW driving pleasure. Choose what suits you the most from particularly high-quality equipment options: Exclusive BMW Individual paint finishes that show style and confidence. Soft, voluminous leather trims and interior trim finishers made of fine woods, which turn the interior into your personal comfort zone. Or go your very own way, only following your ideas – BMW Individual ensures that they become an automotive reality.

ADDITIONAL EQUIPMENT.

Discover even more with the new BMW brochures app. Available now, for your smartphone and tablet.

■ Standard equipment □ Optional equipment



□ In laser high-beam mode, BMW Laserlight in a unique X design illuminates a range of up to 500 m, nearly twice as far as that of conventional headlights. Better visibility in the dark significantly increases safety. The blue X signature and the "BMW Laser" lettering underline the vehicle's technological standards.



■ Dynamic and comfortable: The individually adjustable Sport seats for the driver and front passenger feature numerous electric adjustment options, including backrest width and seat angle. Together with adjustable thigh support, the taller seat and backrest bolsters provide excellent ergonomics and more lateral support during fast cornering.



□ The Aluminium running board* with a brushed, anodised surface and rubber inserts adds a particularly distinctive touch and makes getting in and out of the vehicle more convenient.



□ When open, the Panorama glass roof provides a great deal of fresh air. Closed, it creates a bright, light-flooded atmosphere in the interior. It opens and closes completely automatically at the push of a button, or remotely, and is equipped with slide and lift functions, roller sunblind and wind deflector.



□ The M Leather steering wheel including multifunction buttons¹*, an M badge and an integrated driver-side airbag is featured in three-spoke design. With a steering wheel rim in leather 'Walknappa' Black with black stitching and contoured thumb rests, it provides a direct, athletic steering experience.



■ Ambient light, including Ambient contour lighting in the front and rear doors, creates a relaxed, cosy lighting atmosphere in the interior. The Welcome Light Carpet illuminates the area in front of the car doors when entering and exiting. Six dimmable light designs in White, Blue, Orange, Bronze, Lilac and Green are available.



□ The Roof rails in Aluminium satinated provide the base for a multifunctional BMW roof rack unit.



□ The Soft-Close function pulls the slightly-open door shut automatically and nearly silently.



□ Perfectly fitted and both dirt-repellent and water-resistant, the Floor mats in velour¹ protect the carpet, make cleaning easier and create a high-quality appearance.



□ The Trailer tow hitch with electrically adjustable tow ball and trailer stability control is approved for heavy loads of up to 3,500 kg.



■ The black Sport leather steering wheel* with a thick rim and contoured thumb rests has an exceptionally pleasant, high-grip feel.



□ The manually operated roller sunblind for the rear side windows protects the interior from sunlight and offers privacy.



□ The lumbar support for the driver and front passenger seats can be adjusted both vertically and laterally, allowing for an orthopaedically optimised seating position.

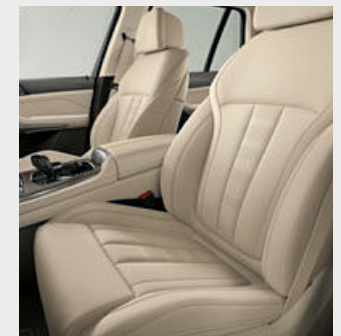

□ The seat heating increases the temperature of the seat and backrest surfaces of the front seats as well as the exterior rear seats. It can be individually regulated to three levels for each seat.

*The availability of some equipment features and functions depends on engine variants or additional options. The market and production availability may vary. You can find detailed information about terms, standard and optional equipment at www.bmw.com or from your BMW Partner.

¹ Standard for M50i and M50d.

ADDITIONAL EQUIPMENT.

Discover even more with the new BMW brochures app. Available now, for your smartphone and tablet.

■ Standard equipment □ Optional equipment



□ The outstanding Harman Kardon surround sound system features a 464 W digital amplifier, nine channels and 16 speakers. Its extremely harmonious sound perfectly fills the interior space. Fully automatic, speed-dependent equalising precisely compensates for any background driving noise.



□ Telephony with wireless charging¹ incorporates a wireless charging dock and a second microphone for a better hands-free voice quality for you and your front passenger. A roof aerial connection improves mobile reception. Two mobile telephones and an audio player can be connected simultaneously via Bluetooth. Also included is the technical capacity for a WiFi hotspot.



■ The BMW Live Cockpit Professional with navigation function* includes two high-quality displays consisting of a high-resolution 12.3" Control Display that can be operated by touch and a fully digital 12.3" instrument display.

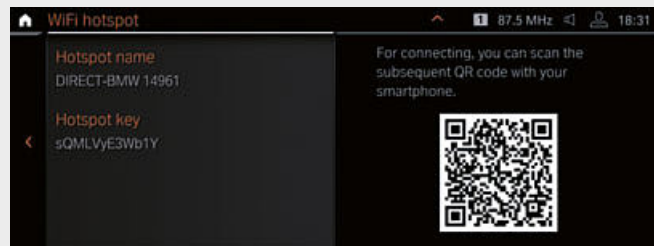

□ Take part in video conference calls on your tablet or stream the final episode of your favourite series on your smartphone. The Wi-Fi Hotspot²* is a way to go online with LTE speed (if available) using the SIM card installed in your vehicle. You and your fellow passengers can surf the Web on up to ten devices.



□ The Automatic air conditioning with 4-zone control allows individual climate comfort for you and your front passenger, as well as for the right and left rear passengers.



□ The top of the BMW Individual instrument panel is covered in leather 'Walknappa' Black. The sophisticated aesthetic of this high-quality trim gives the interior an even more luxurious feel.

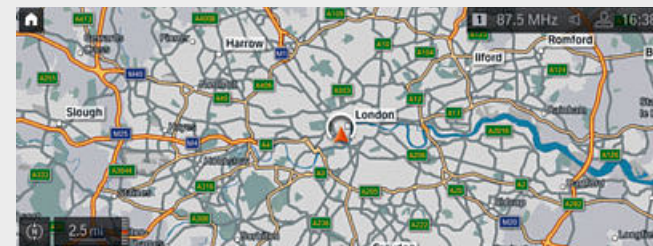

□ Concierge Service, Remote Services, Connected Music, Preparation for Apple CarPlay®, In-Car Experiences or the Connected Navigation Services Real Time Traffic Information and Parking Space Assistant? Why order them individually? Get them all! With the Connected Package Professional*, you can enjoy these BMW ConnectedDrive services as well as BMW Music to test free of charge.

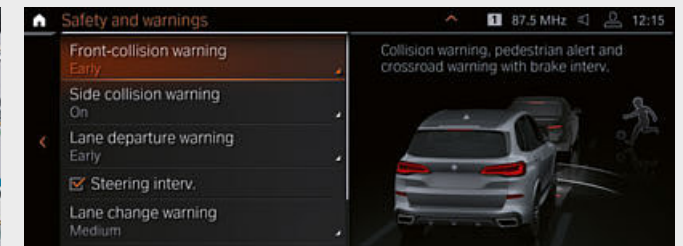

□ The safety package Driving Assistant⁴ includes the camera-based systems front collision warning with braking function, Speed Limit Assist incl. Speed Limit Info with No-overtaking indicator with preview and Lane Departure Warning. Additionally, the radar-based equipment includes Crossing traffic warning rear, Lane Change Warning and Rear collision warning.

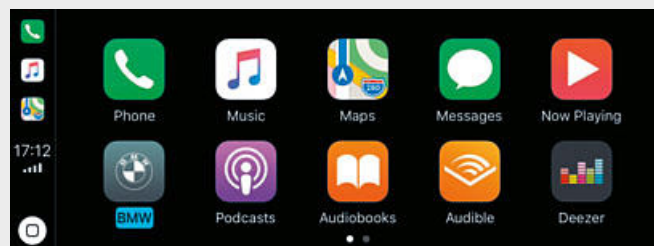

□ Why go without the features of your iPhone in your BMW when you can continue operating it as usual? The Preparation for Apple CarPlay³* gives you remote access to telephony as well as apps like iMessage, WhatsApp, TuneIn, Spotify and Apple Music. You can also use the voice button on the steering wheel to access Siri, Apple's voice assistant.

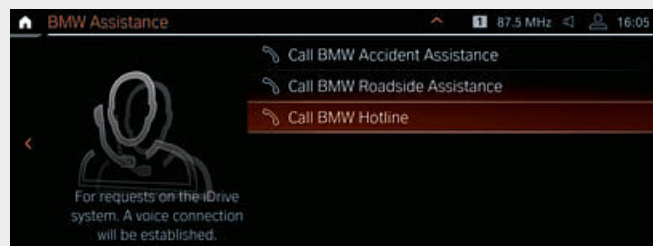

□ Will it be sunny tomorrow in Rome? When does my flight take off? The Concierge Service* is there to help when you are travelling and can support you with any request at the touch of a button. Whether that is a booking at a restaurant, a hotel or a cinema. You can even use it for payments. Wherever you are, whatever you need, the Concierge Service is by your side.



□ The Crossing traffic warning* rear warns you of crossing traffic when pulling out of perpendicular parking spaces. The system works up to a speed of 7 km/h and can be activated and deactivated via the "Park" setting menu.

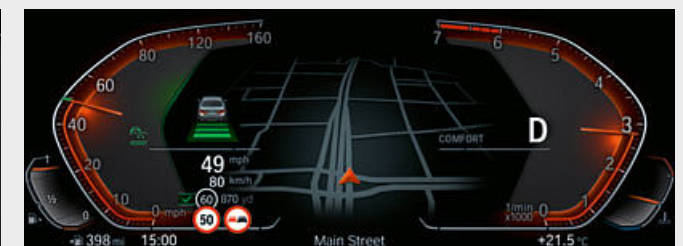

□ The automatic Speed Limit Assist* adapts the Active Cruise Control dynamically to upcoming speed limits. These are determined along the probable route by the navigation system and checked by the camera. The information provided is continuously updated by the entire fleet.

¹ Supports inductive charging for Qi-compatible mobile phones. Special charging cases are available from Original BMW Accessories for selected smartphones that do not support the Qi standard for inductive charging.

² The WiFi hotspot fulfils all in-vehicle requirements for use of the internet with the maximum LTE standard. Usage is subject to cost.

³ Apple CarPlay® compatibility and supported functions depend on the model year and the software installed on the iPhone®. When the Apple CarPlay® preparation is in use, selected vehicle data is transferred to the phone. The mobile phone manufacturer is responsible for further data processing.

⁴ Function may be limited in darkness, fog or bright glare.

*The availability of some equipment features and functions depends on engine variants or additional options. The market and production availability may vary. You can find detailed information about terms, standard and optional equipment at www.bmw.com or from your BMW Partner.

Discover even more with the new BMW Brochures app. Available now, for your smartphone and tablet.

■ Standard equipment □ Optional equipment

M SPORT PACKAGE

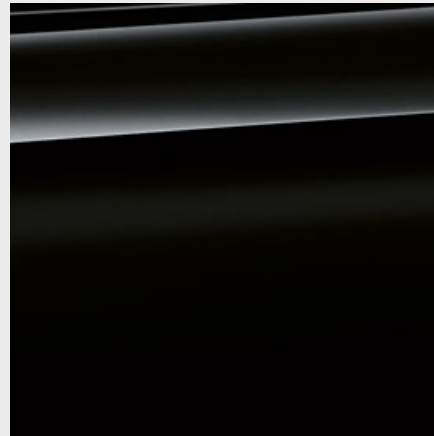

■ Non-metallic 668 Black*



■ Non-metallic 300 Alpine White³*

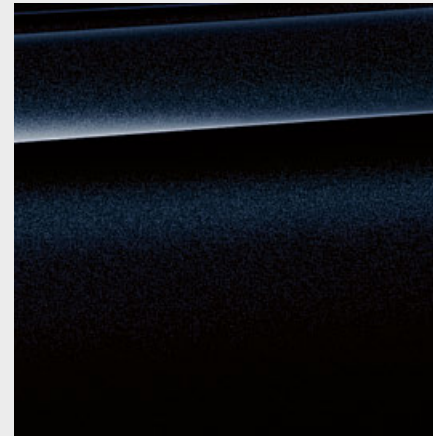

□ Metallic 416 Carbon Black¹

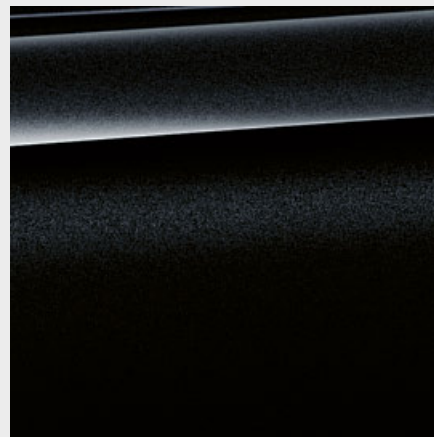

□ Metallic 475 Black Sapphire²



□ Metallic A96 Mineral White²

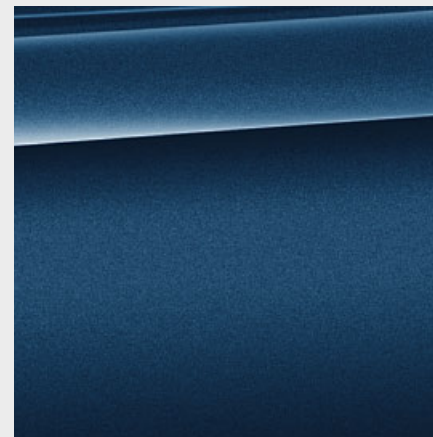

□ Metallic C1M Phytionic Blue²

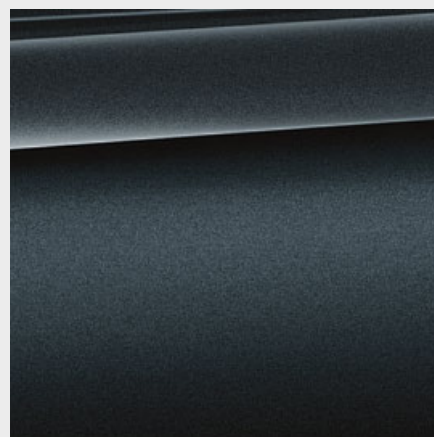

□ Metallic C27 Arctic Grey brilliant effect²



□ Metallic A90 Sophisto Grey brilliant effect

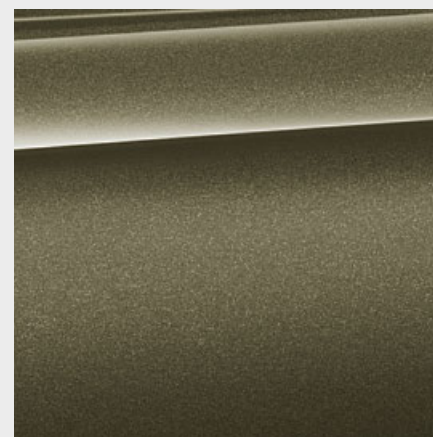

□ Metallic C3D Manhattan*

BMW INDIVIDUAL

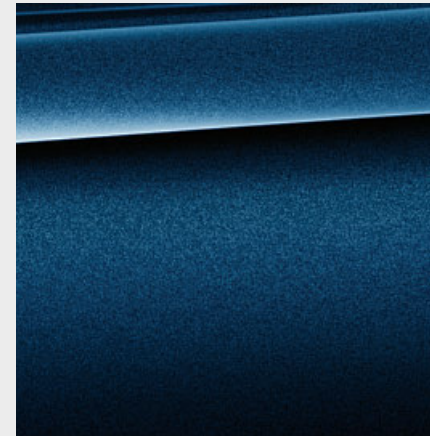

□ BMW Individual C3Z Tanzanite Blue metallic²*

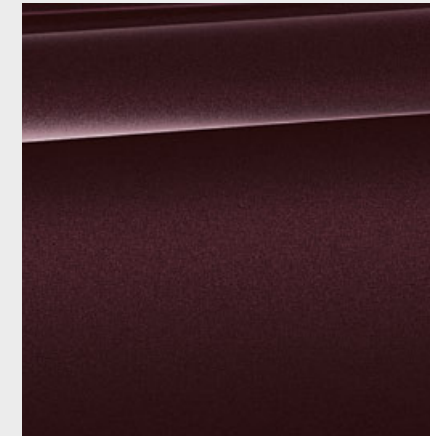

□ BMW Individual X1B Ametrine metallic²*

[Colour samples] These colour samples are intended as an initial guide to the colours and materials available for your BMW. However, experience has shown that printed versions of paint, upholstery and interior trim colours cannot in all cases faithfully reproduce the appearance of the original colour.

Please discuss your preferred colour choices with your BMW partner or in your dealership. There you can also see original samples and be assisted with special requests.

¹ Only available for M50d and M50i or in conjunction with the M Sport package.

² Also optionally available for the M Sport package.

³ Standard for M Sport package, M50i and M50d.

*The availability of some equipment features and functions depends on engine variants or additional options. The market and production availability may vary. You can find detailed information about terms, standard and optional equipment at www.bmw.com or from your BMW Partner.

INTERIOR COLOURS.

Discover even more with the new BMW Brochures app. Available now, for your smartphone and tablet.

■ Standard equipment □ Optional equipment

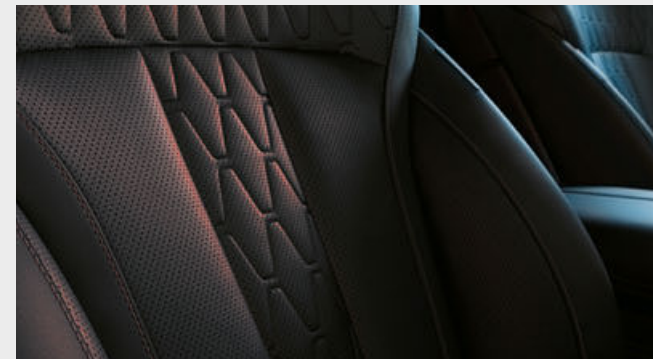
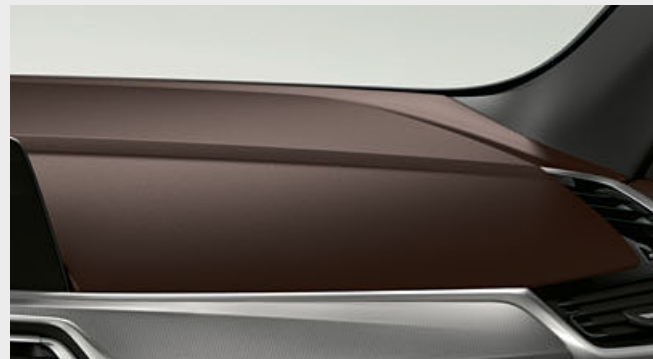

LEATHER

Available with



- Base
- xLine
- M Sport package

Leather 'Vernasca' MCSW design-perforated Black, interior colour Black



- Base
- xLine
- M Sport package

Leather 'Vernasca' MCFY design-perforated Canberra Beige, interior colour Black*



- Base
- xLine
- M Sport package

Leather 'Vernasca' MCFI design-perforated Cognac, interior colour Black



- Base
- xLine
- M Sport package

Leather 'Vernasca' MCHF design-perforated Coffee, interior colour Black



- Base
- xLine
- M Sport package

Leather 'Vernasca' MCEW design-perforated Ivory White, interior colour Black

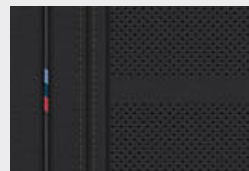

- M Sport package

Leather 'Vernasca' MAH9 Black, contrast stitching Brown, interior colour Black¹

INTERIOR TRIM FINISHERS

Available with

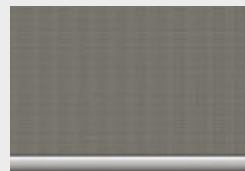

- Base
- xLine
- M Sport package

4KM Interior trim finishers Aluminium 'Mesh effect' dark



- Base
- xLine
- M Sport package

4KP Fine-wood trim Ash Grain brown metallic high-gloss

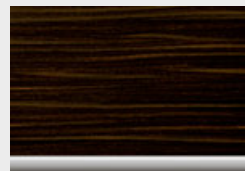

- Base
- xLine
- M Sport package

4KR Fine-wood trim 'Fineline Stripe' brown high-gloss

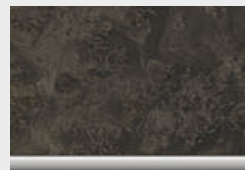

- Base
- xLine
- M Sport package

4KT Fine-wood trim poplar grain light anthracite-brown open-pored



- M Sport package

4KK Interior trim finishers Aluminium Tetragon¹

BMW INDIVIDUAL LEATHER

Available with

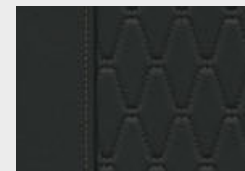

- Base
- xLine
- M Sport package

BMW Individual extended leather trim 'Merino' VASW Black, interior colour Black*



- Base
- xLine
- M Sport package

BMW Individual extended leather trim 'Merino' VATQ Tartufo, interior colour Black.



- Base
- xLine
- M Sport package

BMW Individual extended leather trim 'Merino' VAHF Coffee, interior colour Black*

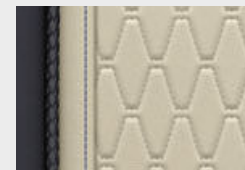

- Base
- xLine
- M Sport package

BMW Individual extended leather trim 'Merino' ZAEI Ivory White with Midnight blue contrast stitching, interior colour Black¹

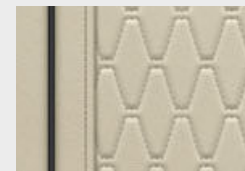

- Base
- xLine
- M Sport package

BMW Individual full leather trim 'Merino' ZBEW Ivory White*

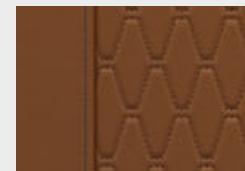

- Base
- xLine
- M Sport package

BMW Individual full leather trim 'Merino' ZBTQ Tartufo with the upper part of the instrument panel in leather 'Walknappa' Black, lower part in leather 'Merino' Tartufo, interior colour Black

BMW INDIVIDUAL INTERIOR TRIM FINISHERS

Available with



- Base
- xLine
- M Sport package

4ML BMW Individual interior trim finishers piano finish Black



- Base
- xLine
- M Sport package

4WW BMW Individual fine-wood trim Ash Grain Silver Grey high-gloss

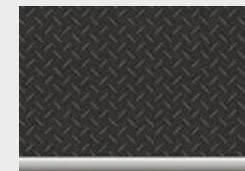

- Base
- xLine
- M Sport package

XET BMW Individual fine-wood trim 'Fineline' Black with Aluminium inserts*

Please note that even normal long- or short-term use can lead to unrecoverable upholstery damage. This can be caused in particular by non-colourfast clothing.

¹ Standard for M50i and M50d.

*The availability of some equipment features and functions depends on engine variants or additional options. The market and production availability may vary. You can find detailed information about terms, standard and optional equipment at www.bmw.com or from your BMW Partner.

WHEELS AND TYRES.

Discover even more with the new BMW brochures app. Available now, for your smartphone and tablet.



□ 19" light alloy wheels V-spoke style 734, Reflex Silver with run-flat tyres, wheel size 9J x 19 with 265/50 R19 tyres.¹



□ 20" light alloy wheels Star-spoke style 736 Ferric Grey with mixed tyres and runflat tyres, front 9J x 20 with 275/45 R20 tyres, rear 10.5J x 20 with 305/40 R20 tyres.¹



□ 20" light alloy wheels V-spoke style 738 in Bicolour with mixed tyres and runflat properties, burnished, front 9J x 20 with 275/45 R20 tyres, rear 10.5J x 20 with 305/40 R20 tyres.²



□ 21" light alloy wheels Y-spoke style 744 Bicolour Orbit Grey with mixed tyres and runflat tyres, burnished, front 9.5J x 21 with 275/40 R21 tyres, rear 10.5J x 21 with 315/35 R21 tyres.¹



□ 21" light alloy wheels Y-spoke style 744 Orbit Grey with mixed tyres and runflat tyres, front 9.5J x 21 with 275/40 R21 tyres, rear 10.5J x 21 with 315/35 R21 tyres.¹



□ 22" M light alloy wheels V-spoke style 747 M Cerium Grey matt with mixed tyres, burnished, front 9.5J x 22 with 275/35 R22 tyres, rear 10.5J x 22 with 315/30 R22 tyres.³



□ 22" BMW Individual light alloy wheels V-spoke style 746 I Orbit Grey with mixed tyres, burnished, front 9.5J x 22 with 275/35 R22 tyres, rear 10.5J x 22 with 315/30 R22 tyres.

ORIGINAL BMW ACCESSORIES.

Equipment 40 | 41

■ Standard equipment □ Optional equipment ○ Accessories



○ The modern BMW roof box in black with titanium silver side panels has a storage capacity of 520 litres and is compatible with all BMW roof rack systems. It can be opened from both sides and features triple central locking on each side which makes it easy to load and provides anti-theft locking.



○ The BMW Advanced Car Eye 2.0 is a highly sensitive full-HD camera that captures events in front of and behind the car, even when it is parked. In the event of disturbances and extraordinary movement outside the vehicle, the camera automatically records the situation in order to document possible accidents or (attempted) break-ins.



○ The BMW Pro 2.0 rear bicycle rack is lightweight yet sturdy and can carry up to 60 kg. Exceptionally easy to use, it carries two bicycles or e-bikes (can be extended to accommodate three bicycles). Its tilt function also allows easy access to the luggage compartment at all times.



○ Anti-slip, water-resistant mat for protecting the luggage compartment from dirt and moisture. In black with stainless steel inlay matching the interior.



○ Precisely fitting protection against moisture and dirt in the front footwell. Featuring a black design with a stainless steel inlay, they perfectly complement the interior.

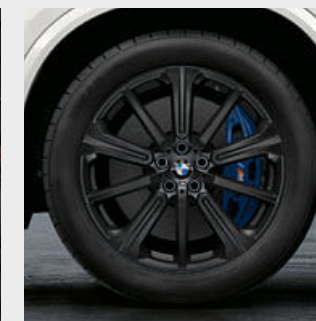

○ High-quality 20" M light alloy wheels Star-spoke style 748 M in Jet Black matt. TPMS summer complete wheel set⁴ with run-flat mixed tyres.



○ Weight-optimised 22" M Performance light alloy wheels Star-spoke style 749 M in Bicolor Jet Black, gloss-lathed. TPMS summer complete wheel set.

¹ Not available for M50d and M50i.

² Only available in conjunction with xLine.

³ Only available for M50d and M50i.

⁴ Also available as a complete winter wheel.

The availability of some equipment features and functions depends on engine variants or additional options. The market and production availability may vary. You can find detailed information about terms, standard and optional equipment at www.bmw.com or from your BMW Partner.

Discover the wide range of innovative solutions available for the exterior and interior, communication and information, and for transportation and the luggage compartment. Your BMW Partner is on hand to advise you on the whole range of Original BMW Accessories

and the BMW M Performance Parts product portfolio. For further information, please visit www.bmw.com

BMW X5	xDrive40i	M50i	xDrive25d	xDrive30d	xDrive40d with mild hybrid technology ^{10, 11}	M50d	xDrive45e
--------	-----------	------	-----------	-----------	---	------	-----------

Weight								
Unladen weight EU ¹	kg	2210–2135	2325	2245–2145	2260–2185	2360–2275	2425–2350	2510
Maximum permissible weight	kg	3010–2800	2995	2940–2820	3090–2860	3170–2940	3160–3010	3150
Permitted load	kg	740–875	745	750–770	750–950	740–885	735–810	715
Permitted trailer load, unbraked ²	kg	750	750	750	750	750	750	750
Permitted trailer load, braked, max. 12% gradient/ max. 8% gradient ²	kg	2500–3500 ³ / 2500–3500 ³	2700–3500 ³ / 2700–3500 ³	1700–2700 ³ / 1700–2700 ³	1700–3500 ³ / 1700–3500 ³	2700–3500 ³ / 2700–3500 ³	2700–3500 ³ / 2700–3500 ³	2700/2700
Luggage capacity	l	550–1870	650–1870	550–1870	550–1870	550–1870	550–1870	500–1720

BMW TwinPower Turbo engine ⁴								
Cylinders/valves		6/4	8/4	4/4	6/4	6/4	6/4	6/4
Capacity	cm ³	2998	4395	1995	2993	2993	2993	2998
Max. output/engine speed	kW (hp)/ rpm	250 (340)/ 5500–6500	390 (530)/ 5500–6000	155–170 (211–231)/4400	183–195 (249–265)/4000	250 (340)/4400	294 (400)/ 4400	155–210 (211–286)/ 5000–6500
With mild hybrid technology	kW (hp)	–	–	–	–	8 (11)	–	–
Max. torque/engine speed	Nm/rpm	450/1500–5200	750/1800–4600	450/1500–3000	620/2000–2500	700/1750–2250	760/2000–3000	450/1500–3500

eDrive motor								
Max. output	kW (hp)	–	–	–	–	–	–	83 (113)
Max. torque	Nm	–	–	–	–	–	–	265
System output	kW (hp)	–	–	–	–	–	–	235–290 (320–394)
System torque	Nm	–	–	–	–	–	–	600

Lithium-ion high-voltage battery								
Battery type/net battery capacity	kWh	–	–	–	–	–	–	Li-ion/20.9
Electric range/Maximum total range, combined ⁷	km	–	–	–	–	–	–	97–86/ ⁹
Charging time (AC rapid charging with BMW Wallbox) ⁸	h	–	–	–	–	–	–	approx. 05:00

Power transmission								
Type of drive		All-wheel	All-wheel	All-wheel	All-wheel	All-wheel	All-wheel	All-wheel
Standard transmission		8-speed Steptronic	8-speed Steptronic Sport	8-speed Steptronic	8-speed Steptronic	8-speed Steptronic	8-speed Steptronic Sport	8-speed Steptronic

Driving performance								
Top speed	km/h	243	250 ³	222–216	230–226	245	250 ³	235–205
Top electric speed	km/h	–	–	–	–	–	–	135
Acceleration 0–100 km/h	s	5.5–5.7	4.3	7.5–9.0	6.5–7.0	5.5–5.6	5.2–5.3	5.6–6.6

Consumption ^{4, 5} - All engines conform to the EU6 standard								
Urban	l/100 km	9.6–10.1	13.7–14.2	6.0–6.4	6.7–7.6	7.2–7.8	8.0–8.1	–
Extra-urban	l/100 km	7.1–8.1	8.5–8.6	5.3–5.7	5.7–6.5	5.1–5.6	6.2–6.8	–
Combined	l/100 km	8.0–8.9	10.4–10.7	5.6–5.9	6.1–6.8	5.9–6.4	6.9–7.2	1.7–2.0
Consumption range, combined	kWh/ 100 km	–	–	–	–	–	–	21.3–23.5
Exhaust emissions standard (type-certified)		EU6d-temp	EU6d-temp	EU6d	EU6d-temp	EU6d	EU6d-temp	EU6d-temp
Combined CO ₂ emissions	g/km	183–203	238–243	147–156	159–174	154–167	180–190	38–46
Tank capacity, approx.		83	83	80	80	80	80	69

Wheels/tyres								
Tyre dimensions		255/55 R18 W	275/40 R21 Y 315/35 R21 Y	255/55 R18 W	255/55 R18 W	265/50 R19 W	275/40 R21 Y 315/35 R21 Y	265/50 R19 W
Wheel size		8.5J x 18	9.5J x 21 10.5J x 21	8.5J x 18	8.5J x 18	9J x 19	9.5J x 21 10.5J x 21	9J x 19
Material		Light alloy	Light alloy	Light alloy	Light alloy	Light alloy	Light alloy	Light alloy

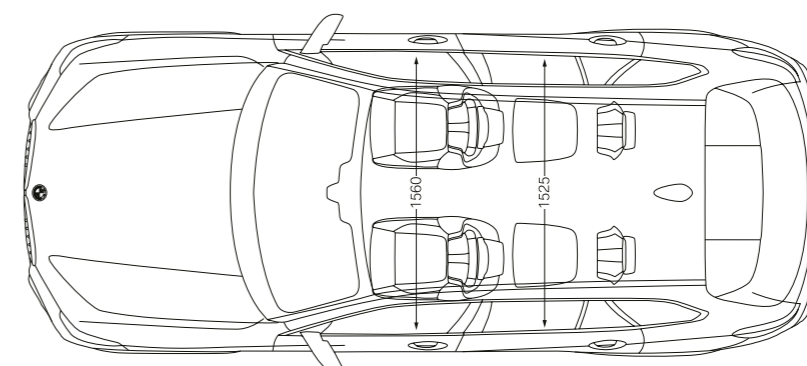
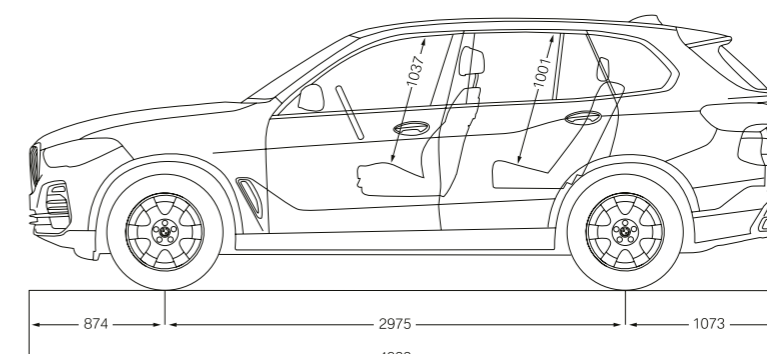
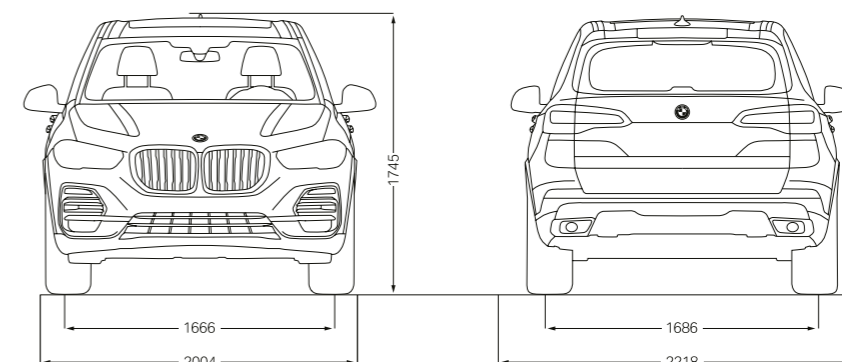

All dimensions in the technical drawing are given in millimetres. Height without roof aerial is 1466 mm. Front track width of the BMW X5 M50d: 1684 mm, rear: 1689 mm. The figures for performance, fuel consumption and CO₂ emissions refer to vehicles with standard transmission.

¹ The EC unladen weight refers to a vehicle with standard equipment and does not include any optional extras. The unladen weight includes a 90% full tank and a driver weight of 75 kg. Optional equipment may affect the weight of the vehicle, the payload and the top speed if the selected equipment has an impact on the vehicle's aerodynamics.

² The actual total weight of the trailer must not exceed the maximum trailer load, taking into account the maximum tow bar download.

³ Electronically limited.

⁴ Performance data of petrol engines apply to vehicles using RON 98 fuel. Fuel consumption data apply to vehicles using reference fuels in accordance with EU Regulation 2007/715. Unleaded RON 91 and higher with a maximum ethanol content of 10% (E10) may also be used. BMW recommends RON 95 super unleaded petrol.

⁵ The data for fuel consumption, CO₂ emissions and energy consumption are determined in accordance with the measurements processes as defined by European Regulation (EU) 2007/715 in the applicable version. Data refer to a vehicle with base-level equipment in Germany, and the ranges account for differences according to the selected wheel and tyre size and the optional equipment and may change during the configuration process. Figures have been determined on the basis of the new WLTP test cycle and have been converted back into NEDC figures for comparability.

⁶ Only with factory-fitted trailer tow hitch.

⁷ Range depends on the equipment and various factors. In particular: personal driving style, route characteristics, exterior temperature, heating/air conditioning, pre-conditioning and the chosen equipment.

⁸ Dependent on the local electricity infrastructure. Charging time corresponds to an 80% charge of maximum capacity.

⁹ Provisional figures; any missing figures were unavailable at the time of publication.

¹⁰ This engine version is not available in all countries. For further information, please contact your local BMW Partner.

¹¹ Model expected to be available from Q2/2020.



YOUR NEW SPEED DATING APP.

DOWNLOAD NOW THE BMW BROCHURES APP FROM YOUR APP STORE AND DISCOVER DRIVING PLEASURE!

BMW X5 xDRIVE40i WITH M SPORT PACKAGE:

BMW TwinPower Turbo 6-cylinder petrol engine, 250 kW (340 hp), 22" M light alloy wheels Double-spoke style 742 M Bicolour with mixed tyres, exterior colour in Mineral White metallic, comfort seats in BMW Individual extended leather trim 'Merino' Coffee, interior trim finishers in fine-wood trim 'Fineline Stripe' brown high-gloss.

The models illustrated in this medium show the equipment and configuration options (standard and optional) for vehicles produced by BMW AG for the German market. Alterations in standard and optional equipment and the configurations available for the different models may occur after 11/12/2019, the editorial deadline for this medium, or according to the specific requirements of other markets. Your local BMW Partner is available to provide further details. Subject to change in design and equipment. Of course, each vehicle is designed for economical recycling after its long-running life. You can find more information regarding your end-of-life vehicle on our website www.bmw.de/recycling. © BMW AG, Munich, Germany. Not to be reproduced wholly or in part without prior written permission of BMW AG, Munich.