



Sheer
Driving Pleasure



THE X2

THE BMW X2.



INNOVATION AND TECHNOLOGY.



16 Dynamics and efficiency
17 Drivetrain and suspension



18 Driver assistance
19 Safety



20 Connectivity and infotainment
21 Comfort and functionality

EQUIPMENT.



22 Package



30 Additional equipment

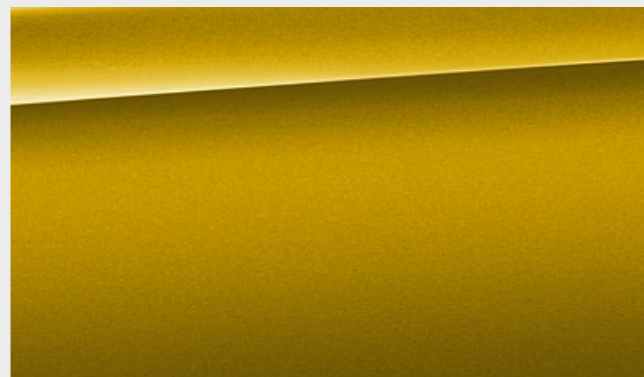

36 Exterior colours

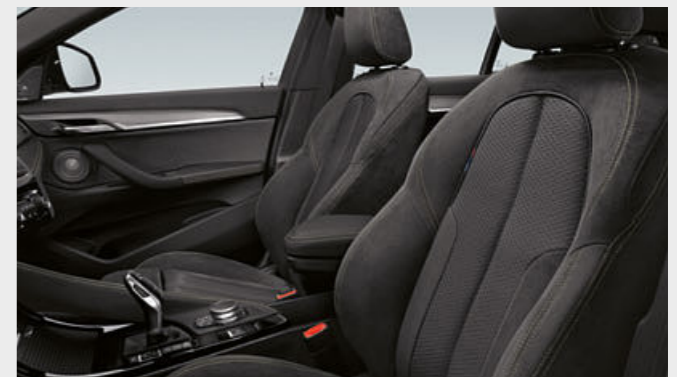

38 Interior colours

DIGITAL DISCOVERY: THE NEW BMW BROCHURES APP.



More information, more driving pleasure: The new BMW brochures app offers you a brand new digital and interactive BMW experience. Download the BMW brochures app for your smartphone or tablet now and explore new perspectives of your BMW.



40 Wheels and tyres



41 Original BMW Accessories

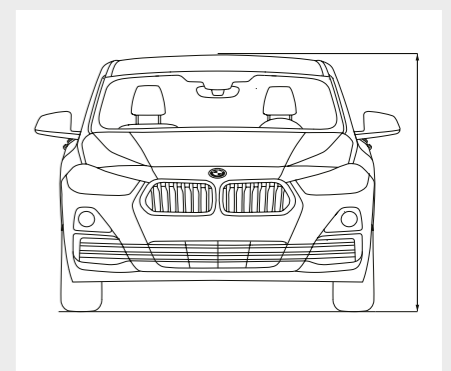

42 Technical data



I WANT IT ALL.

AND MORE.
BE THE ONE WHO DARES.



I AM EXHILARATION
AT FIRST GLANCE.

FOCUSED, FORWARD-THRUSTING FRONT || BRAND NEW,
REVOLUTIONARY KIDNEY GRILLE DESIGN || LARGE CENTRAL
AIR INTAKE WITH HEXAGONAL FRAME IN FROZEN GREY* ||
FLANKED BY TWO STRIKING, TRIANGULAR AIR INTAKES*

* Available as optional equipment.



I DON'T THINK AFTER,
I THINK AHEAD.

BMW CONNECTED DRIVE APPS AND SERVICES* || BMW CONNECTED*
PERSONAL MOBILITY ASSISTANT || INTELLIGENT DRIVER
ASSISTANCE SYSTEMS, INCLUDING DRIVING ASSISTANT PLUS* ||
BMW HEAD-UP DISPLAY* || 8.8" TOUCH DISPLAY*

* Available as optional equipment.
Some ConnectedDrive Services may differ between countries.
Please consult your local BMW partner for more information.



YOU'LL LIKE
WHAT YOU SEE.

SPORTY SILHOUETTE II HOFMEISTER KINK INTEGRATED IN C-PILLAR II
EXCLUSIVE BMW EMBLEM POSITION II SQUARED-OFF WHEEL-ARCHES II
SIDE SKIRTS WITH HEXAGONAL SHAPE IN BODY COLOUR*

* Available as optional equipment.



I START AT THE LIMIT.

POWERFUL AND EFFICIENT BMW TWIN POWER TURBO ENGINES II BMW xDRIVE*
WITH HILL DESCENT CONTROL II M SPORT SUSPENSION* AND M SPORT STEERING* II
M SPORT BRAKE* II HIGH IMPACT THROUGH DISTINCTIVE AND MEMORABLE REAR
DESIGN II POWERFULLY FORMED M REAR SPOILER* II LED REAR LIGHTS
WITH DYNAMIC COMBINATION OF CLASSIC BMW X AND BMW COUPÉ L FORMS

* Available as optional equipment.



I AM THE BMW X2.

REVOLUTIONARY DESIGN, INNOVATIVE TECHNOLOGY AND AN IRRESISTIBLE LIFESTYLE.

THE BMW X2 GOES NEW WAYS IN EVERY WAY, THRILLS WITH ITS IMPRESSIVE TALENTS AND PROMISES A DRIVING EXPERIENCE THAT, FROM HEAD TO TOE, FROM BMW HEAD-UP DISPLAY* TO ACCELERATOR PEDAL, OFFERS PURE HAPPINESS. LIFE GETS EVEN MORE EXCITING – **IN THE BMW X2.**

* Available as optional equipment.

DYNAMICS AND EFFICIENCY.

BMW EFFICIENTDYNAMICS.
LESS EMISSIONS. MORE DRIVING PLEASURE.

MORE POWER FROM LESS FUEL.

More power from three to 12 cylinders. Consume less, experience more – the BMW TwinPower Turbo engines offer the greatest possible dynamic performance with the greatest possible efficiency thanks to the newest injection systems, variable output control and sophisticated turbocharger technology. Whether diesel or petrol, and no matter how many cylinders, the engines from the BMW EfficientDynamics engine family allow markedly more agile power delivery and outstanding responsiveness even at low rpm, while being fuel-efficient and low in emissions.

MORE DRIVING PLEASURE, LESS EMISSIONS.

BMW EfficientDynamics is a technology package that includes not only the drive, but rather the whole vehicle concept and intelligent energy management. Provided as standard in every BMW, a variety of innovative technologies contribute to continuously improving efficiency. Via engine efficiency measures, electrification, lightweight construction methods and optimised aerodynamics, BMW has managed to reduce the CO₂ emissions of its fleet significantly.

MORE DYNAMICS, LESS WEIGHT.

Lower weight with intelligent lightweight construction. Special consideration for every last detail – intelligent lightweight construction means that the optimal material is found and implemented for each part of the vehicle. With extremely light high-tech materials such as aluminium and carbon fibre, BMW EfficientLightweight is pursuing the goal of minimising vehicle weight. That leads to even more dynamic performance, increased stability and heightened safety and comfort.



AERODYNAMICS

Targeted aerodynamic changes to the vehicle body such as air vent control, Air Curtain and Air Blades improve its air resistance. The airflow-optimised components contribute not only to reduced fuel consumption, but also reduce the level of noise in the interior.

DRIVING EXPERIENCE CONTROL INCL. ECO PRO MODE

The Driving Experience Control lets the driver choose between the standard COMFORT mode, ECO PRO Mode which is geared towards efficiency, and SPORT mode which enables even more dynamic driving. ECO PRO mode adjusts the characteristics of the accelerator, Steptronic transmission and the heating/air conditioning settings to make the drive as fuel-efficient as possible.

INTELLIGENT START/STOP FUNCTION

The Intelligent Start/Stop function^{1,*} enhances driving comfort by switching off the engine only when a specific standing time is expected.

IN THE BMW X2.

¹ Available as optional equipment.

² Electronically limited.

³ Standard for BMW X2 M35i.

* The availability of some equipment features and functions depends on engine variants or additional options. The market and production availability may vary. You can find detailed information about terms, standard and optional equipment at www.bmw.com or from your BMW Partner.

DRIVETRAIN AND SUSPENSION.

Innovation and Technology 16 | 17



ENGINE HIGHLIGHTS OF THE BMW X2.

BMW X2 M35i

BMW TwinPower Turbo four-cylinder petrol engine with TwinScroll turbocharger with 225 kW (306 hp) and 450 Nm torque
Acceleration 0–100 km/h: 4.9 s
Top speed: 250 km/h²
Combined fuel consumption: 6.9–7.1 l/100 km
Combined CO₂ emissions: 158–161 g/km

BMW X2 xDrive20d

BMW TwinPower Turbo four-cylinder diesel engine with two-stage turbocharger and variable turbine geometry, NOx storage catalytic converter and SCR system with 140 kW (190 hp) and 400 Nm torque
Acceleration 0–100km/h: 7.7 s
top speed: 221 km/h
Combined fuel consumption: 4.7–4.9 l/100 km
Combined CO₂ emissions: 124–128 g/km

Agility, outstanding steering characteristics and impressive comfort are the hallmarks of the running gear's driving behaviour. The front single-joint trailing-arm axle, compact multi-arm rear axle with separate spring/damper arrangement and high level of body rigidity lay the foundations for this excellence. Its axle kinematics, gas-filled shock absorber and stabilisers are extremely dynamics-oriented.

Dynamic Damper Control¹ with a suspension lowering of ten millimetres combines driving dynamics and comfort with a high level of safety. The driver has the option of preselecting the damper characteristics via the Driving Experience Control. Along with the standard COMFORT setting, SPORT mode is also available.

M Sport suspension^{1,3} – which includes a chassis which is lowered by 10 millimetres – is characterised by more athletic suspension settings. In addition to shorter bearing springs, it also encompasses tighter damper settings. Together these lead to a lower centre of gravity. This results in even more direct settings, along with reduced body roll, leading to improved agility.

The **M Sports^{1,3,*}** steering with Servotronic creates a direct and agile steering response and ensures less physical effort is required to turn the wheel. The vehicle can be directed more precisely, offering highly athletic handling characteristics, particularly on winding roads. It also makes steering easier while parking, turning and manoeuvring.

The intelligent BMW **xDrive** all-wheel drive system smoothly and variably distributes drive power to the front and rear wheels for maximum traction, driving dynamics and safety in every driving situation. For even better agility, the electronically controlled power distribution for instance counterbalances oversteer or understeer on bends.

The **8-speed Steptronic Sport^{1,3}** transmission offers incredibly sporty gear changes. Whether automatic or manual using gearshift paddles or gear lever.

The **7-speed Steptronic Sport transmission with double clutch^{1,*}** offers incredibly sporty gear changes, both automatically and manually via the selector lever or gearshift paddles.

The figures for output, fuel consumption and CO₂ emissions refer to vehicles with a standard transmission.

Further information on fuel consumption and CO₂ emissions can be found in technical data or consult your local BMW partner.

DRIVER ASSISTANCE.



The **Driving Assistant**^{1,2,*} safety package draws the driver's attention to an unintentional lane change² or possible collision and brakes automatically in the event of an emergency.

The **Driving Assistant Plus**^{1,2,*} equipment option not only includes systems from the Driving Assistant equipment, which include the Lane Departure Warning, Approach control warning and Person warning with light city braking function, the High-beam assistant and Speed Limit Info³, but also additionally includes Camera-based cruise control with Stop&Go function as well as the Traffic jam assistant. The Camera-based cruise control with Stop&Go function maintains your desired speed in a range of 0 to 140 km/h and keeps the distance to the vehicle in front. The Stop&Go function even controls speed down to a standstill, and automatically restarts the vehicle after an interval of up to three seconds. The vehicle accelerates back up to the set speed if the RES button or accelerator are pressed. Traffic jam assistant eases your burden on motorways and in other monotonous traffic situations. At speeds of up to 60 km/h, the system lets the car simply "glide along" with the other cars in dense traffic situations, making traffic jams less stressful. It automatically maintains the desired distance from the vehicle ahead and regulates the car's speed down to standstill, all while providing active steering support – as long as you keep one hand on the steering wheel.

The **Parking Assistant**^{1,4} makes parallel parking easier. The system works by measuring potential spaces while driving past them at a low speed. When a suitable space has been found, the Parking Assistant takes over steering, while you are responsible for selecting the correct gear, as well as pressing the accelerator and brake.

The full-colour **BMW Head-Up Display**^{1,3} projects information relevant to the journey directly into the driver's field of vision, thereby allowing them to fully concentrate on driving. The display includes information such as the current speed, navigation directions, Speed Limit Info incl. no-overtaking indicator, along with telephone and entertainment lists.

The **extended contents of the instrument cluster**¹ in Black Panel technology include a larger high-resolution TFT display which can show navigation tips, operational messages and various vehicle information such as lists of radio stations, music titles or contact information.

The optional **Hill Descent Control** (HDC) in the xDrive models is a system which, when activated, ensures that the vehicle can master the steepest downhill runs automatically and safely at just above walking pace, without the driver having to brake.

¹ Available as optional equipment.

² Function may be limited in darkness, fog or bright glare.

³ The information in the BMW Head-Up Display is not fully visible when viewed through polarised sunglasses. The exact content shown will depend on the equipment options chosen. Further optional equipment is required for content to be displayed.

⁴ The driver is responsible for constantly monitoring the automated parking procedure in accordance with local road laws.

*The availability of some equipment features and functions depends on engine variants or additional options. The market and production availability may vary. You can find detailed information about terms, standard and optional equipment at www.bmw.com or from your BMW Partner.

SAFETY.

■ Standard equipment □ Optional equipment



■ The **Attentiveness assistant** checks the driver's behaviour for signs of fatigue, such as inaccurate lane keeping. This system analyses the steering response and reacts to irregular driving behaviour: The Control Display then shows a message recommending the driver to take a break in order to avoid dangerous situations.

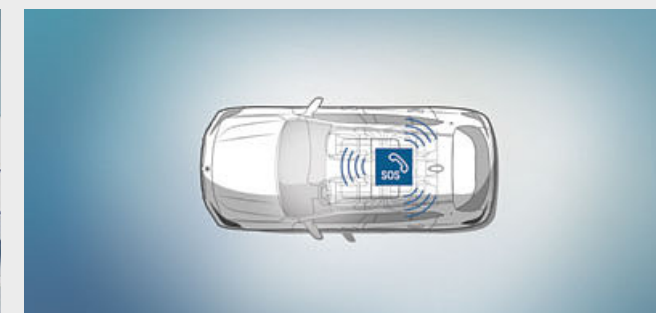

□ If it comes to an accident, speed is of the essence. The **Intelligent Emergency Call**^{*} provides help and becomes a lifesaver in an emergency. It contacts specially trained call centre staff, who look after you and your passengers in their own language until the first aiders arrive, and forwards important information to the emergency services.

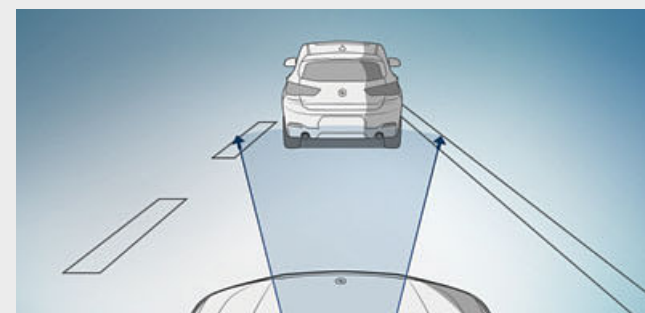

□ **Approach control warning**² with light city braking function warns of potentially critical situations to help prevent accidents. If there is a risk of collision with a vehicle moving or standing ahead, it provides a two-stage warning and, if necessary, pre-conditions the brakes for increased responsiveness. In case of an emergency, the system initiates braking, ensuring that the collision speed is significantly reduced.

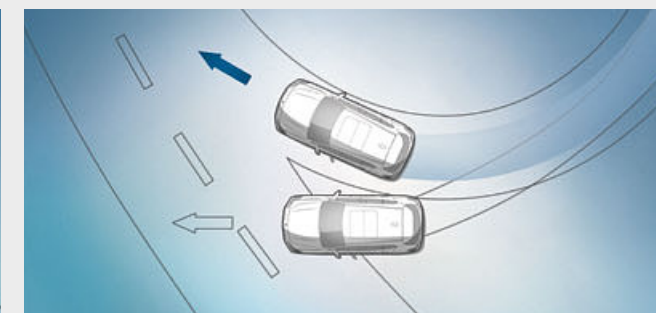

■ **Dynamic Stability Control (DSC)** permanently assesses the vehicle's movements and stabilises it using engine and braking regulation when unstable driving conditions are detected. Additional features of DSC are, for example, brake drying, braking readiness or the Hill-Start assistant, which holds the vehicle briefly in place when starting on inclines to prevent it from rolling backwards.

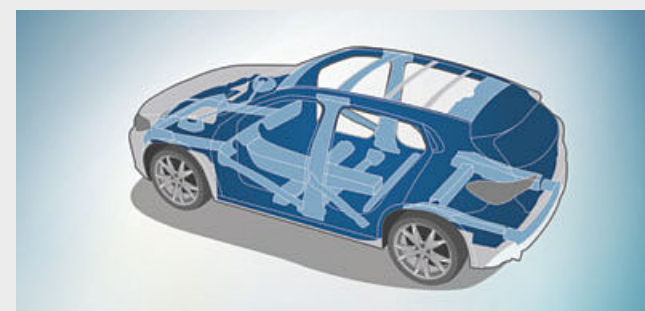

■ The extremely torsionally stiff but light **body construction** provides the basis for sporty driving dynamics, high-precision steering and agility. What is more, it offers passengers perfect all-round protection at all times.

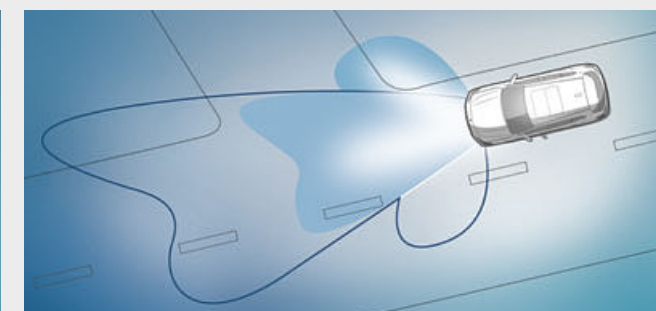

■ The **LED headlights** with extended contents offer a bright and efficient bi-LED light for low and high-beam headlights. The bend lighting and cornering lights with LED technology are also integrated and allow for variable light distribution with increased side illumination for city driving and on country roads.

The Standard and Optional equipment may differ between countries. Please consult your local BMW partner for more information.

CONNECTIVITY AND INFOTAINMENT.

BMW ConnectedDrive
Connected to be free.

CONNECTED
FOR OVER **20** YEARS.

Focused on the future – from the very beginning. By the 1990s, BMW had already made headway in connected mobility. Another milestone of the digital future was surpassed in 2004: vehicles with built-in SIM cards. Then came the first online functionality, Google Services and innovative display systems such as the BMW Head-Up Display. Throughout this process, the desires of the customer have always taken centre stage. In a first for a premium automobile manufacturer, BMW makes it possible to book and pay for services flexibly via the BMW ConnectedDrive Store, in the vehicle or on a computer at home. And with the introduction of BMW Connected, the Open Mobility Cloud and the BMW Intelligent Personal Assistant, BMW is taking the next steps into the future of mobility.

MORE THAN 20
SERVICES AND APPS IN THE
BMW CONNECTED DRIVE STORE.

ConnectedDrive open the gate to the digital world of BMW. Use vehicle apps such as news, weather, office or online search on the go and be well informed at all times. Via the ConnectedDrive Store or directly in your BMW, you can book additional digital services such as Connected Music or Concierge Service – anytime, anywhere, easily and flexibly.

IN TOUCH **24/7** WITH
BMW CONNECTED.

What would it be like if you were never late again? What if your BMW already knew your preferred destinations? How would you like reliable navigation, whether you're sitting in your vehicle or not? BMW Connected provides you with the information you want, when and where you want it. BMW Connected is a personal mobility assistant which facilitates your everyday mobility and aids you in reaching your destinations relaxed and on time. With the BMW Connected app, mobility-relevant information such as recommendations for optimal departure times are available at any time via smartphone or smartwatch and can be seamlessly transmitted to the car.



BMW CONNECTED+

Your BMW and smartphone merge to form a single unit with BMW Connected+^{1,*}. Use the personalised features of the BMW Connected app both inside and outside your car. Share journey information with friends, get directions right up to the door of your destination or control your smart home.

WiFi HOTSPOT

Take part in video conference calls on your tablet or stream the final episode of your favourite series on your smartphone. The Wi-Fi Hotspot^{1,2,*} is a way to go online with LTE speed (if available) using the SIM card installed in your vehicle. You and your fellow passengers can surf the Web on up to ten devices.

CONCIERGE SERVICE

Will it be sunny tomorrow in Rome? When is my flight and where is the best restaurant in the city? Concierge Services^{1,*} are there to help when you are travelling and can support you with any request at the touch of a button – individual, personal and fast. Wherever you are, whatever you need.

IN THE BMW X2.

¹ Available as optional equipment.

² The Wi-Fi hotspot enables in-vehicle use of the internet with the maximum LTE standard. Use is subject to cost.

³ The information in the BMW Head-Up Display is not fully visible when viewed through polarised sunglasses. Content shown will depend on the equipment options chosen. Further optional equipment is required to display specific items.

*The availability of some equipment features and functions depends on engine variants or additional options. The market and production availability may vary. You can find detailed information about terms, standard and optional equipment at www.bmw.com or from your BMW Partner.

COMFORT AND FUNCTIONALITY.

Innovation and Technology 20 | 21



The **Automatic air conditioning**¹ with two-zone control and automatic temperature control features separate controls for the driver and front passenger. It also includes Automatic Air Recirculation (AAR), a micro active carbon filter, a fog and solar sensor, as well as rear air vents.

Navigation Plus^{1,*} features a BMW Head-Up Display³, an iDrive Controller, a built-in 10.25" touch display and an instrument cluster with high-resolution 5.7" TFT display. The system is operated intuitively using either the iDrive Controller, the direct menu control buttons and eight functional bookmarks, Intelligent Voice Control or the touchscreen with interactive tiles.

The driver utilizes BMW **"Media"** communications and information system via the central Control Display, the multifunction steering wheel and the BMW iDrive Controller for intuitive operation of the radio, the hands-free facility and the audio streaming functions via Bluetooth or USB port.

The **through-loading** system includes rear seat backrests that can be flexibly divided in a 40:20:40 ratio. For example, two passengers can be seated comfortably in the rear, while long objects such as ski and snowboard bags can be transported at the same time. The centre armrest features two cupholders.

In combination with a special tow ball head, the **Rear-mounted rack preparation**^{1,*} allows the Original BMW Accessories bike rack to be easily mounted. This feature includes a swivelling electrical socket to connect the additional rear lights, and a fixture on the vehicle for mounting the rear bicycle rack.

Some ConnectedDrive Services may differ between countries. Please consult your local BMW partner for more information.

Discover more with the new BMW catalogue app. Now available for your smartphone and tablet.

■ Standard equipment □ Optional equipment



■ In the BMW X2, classic BMW driver orientation, the dynamic lines of the surfaces plus contrast and decorative stitching in the instrument panel combine to create an exclusive space focused on the driving experience. The functional control elements are in matt Black and the audio and air conditioning control elements as well as the centre console are finished in high-gloss Black and are shown here in combination with the dark matt Oxide Silver interior trim with high-gloss Black accents.

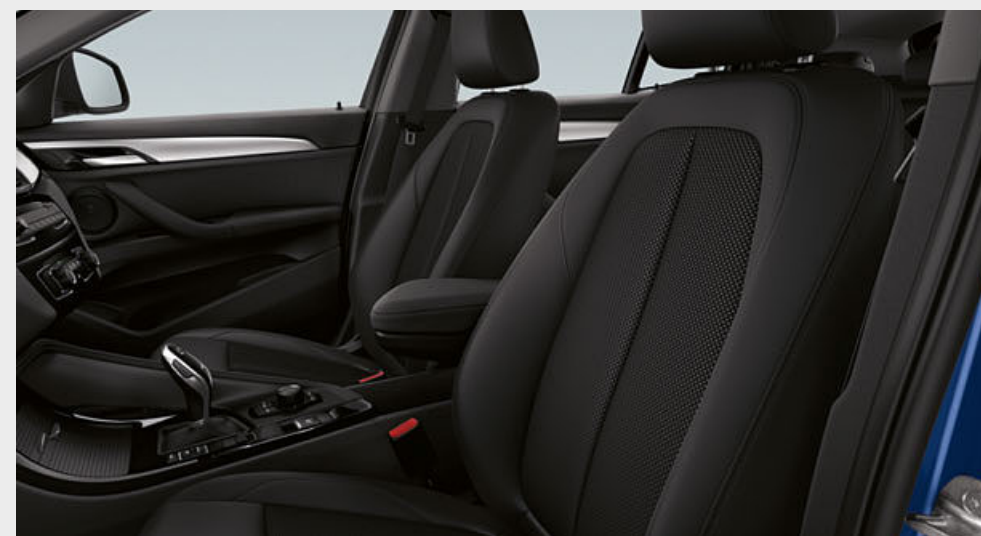

■ The elevated seating position offers a good overview and helps to ensure optimal control while driving. The standard seats, shown here in standard 'Grid' Anthracite cloth, offer optimal hold and comfort thanks to plenty of adjustment possibilities.

Selected base model equipment features:

- 17" light alloy wheels V-spoke style 560
- Standard seats, front incl. seat length, seat height and backrest tilt adjustment in Grid cloth, other upholstery available
- Air conditioning
- Storage package incl. stainless steel edge trim
- Media with 6.5" Control Display and BMW iDrive Controller, voice control with Bluetooth connectivity incl. audio streaming for compatible smartphones and USB interface
- Free-form LED headlights with daytime running lights in LED technology, rear lights and brake lights in LED technology
- LED fog lights
- Driving Experience Control
- Performance Control
- Servotronic
- Leather steering wheel
- Electronic parking brake
- Rain sensor with automatic headlight activation
- Heated exterior door mirrors and windscreen washer nozzles
- 40/20/40 split-folding rear seats with two locking positions incl. armrest and two cupholders
- Luggage compartment with folding shelf, storage tray with net and strap, double USB ports in front and rear centre consoles and a 12V socket in the luggage compartment

- Six loudspeakers, 100 watts
- Eight bookmarks
- Roller cover for cupholder and front centre console tray
- Instrument panel flap compartment, driver's side
- Instrument cluster with Black Panel technology



■ 17" light alloy wheels V-spoke style 560 in Reflex Silver, wheel size 7.5J x 17 with 225/55 R17 tyres.



□ 19" light alloy wheels Y-spoke style 511 Orbit Grey, gloss-lathed with runflat tyres, wheel size 8J x 19 with 225/45 R19 tyres.

M SPORT PACKAGE.

Equipment 24 | 25

Discover more with the new BMW catalogue app. Now available for your smartphone and tablet.

powered by 

■ Standard equipment □ Optional equipment



■ The interior is stretched horizontally by the continuous accent trim and the extensive decorative trims. The M leather steering wheel in the BMW M specific three-spoke design with rim in Walknappa leather and contoured thumbrests sits particular well in the hands. The sporty look in the interior is further enhanced by the interior trim finishers Aluminium Hexagon with highlight trim finisher Blue matt.



■ The standard Sport seats in a specific design offer even more comfortable hold thanks to raised seat base and backrest sides as well as additional adjustment possibilities such as seat depth and backrest width. The seats in optional leather 'Dakota' Black with perforations and Blue highlight combine perfectly with the interior trim finishers and underscore the sporty ambience.

M Sport model exterior equipment¹:

- M Aerodynamics package including front apron with insert in Dark Shadow metallic, specially designed air inlets and side skirts in the body colour with inserts in Dark Shadow metallic, wheel arch trim and claddings in the body colour and rear apron with diffuser insert in Dark Shadow metallic
- 19" M light alloy wheels Double-spoke style 715 M with run-flat properties, alternatively
- 20" M light alloy wheels Double-spoke style 716 M with run-flat properties
- Lowered M Sport suspension, alternatively
- Lowered Adaptive suspension, or Standard suspension
- M Sport steering
- BMW Individual high-gloss Shadow Line, alternatively
- BMW Individual Exterior Line Aluminium satinated
- M designation on the sides
- Exclusive paintwork in Misano Blue metallic; other paintworks available

Model M Sport interior equipment¹:

- M door sill finishers front and M driver footrest
- Sport seats for driver and front passenger in cloth 'Micro Hexagon' Sensatec Black; other upholsteries available
- M Leather steering wheel
- Vehicle key with exclusive M designation
- BMW Individual headliner anthracite
- Interior trim finishers in Aluminium Hexagon with highlight trim finishers in Blue; other trims available
- Shortened gear lever with M designation²
- Lights package
- Exclusive LED optical fibre in the door trims



■ 19" M light alloy wheels Double-spoke style 715 M, Orbit Grey, gloss-lathed with runflat tyres, wheel size 8J x 19 with 225/45 R19 tyres.



□ 20" M light alloy wheels Double-spoke style 716 M, Jet Black, gloss-lathed with runflat tyres, wheel size 8J x 20 with 225/40 R20 tyres.

¹ The following features are additionally available as an option: M Sport brake, M Sport seats* and M seat belts.

² Only available in conjunction with manual transmission.

*The availability of some equipment features and functions depends on engine variants or additional options. The market and production availability may vary. You can find detailed information about terms, standard and optional equipment at www.bmw.com or from your BMW Partner.

The Standard and Optional equipment may differ between countries. Please consult your local BMW partner for more information.

M SPORT X PACKAGE.

Equipment 26 | 27

Discover more with the new BMW catalogue app. Now available for your smartphone and tablet.

■ Standard equipment □ Optional equipment



■ The distinctive contrast stitching in the instrument panel and centre console is colour-matched to the contrast stitching in the seats and the floor mat piping, emphasising the dynamic driver orientation of the cockpit. The Aluminium Hexagon Anthracite interior trim with Pearl Chrome accent and the M driver footrest as well as the M leather steering wheel with its grippy rim are further sporty details.

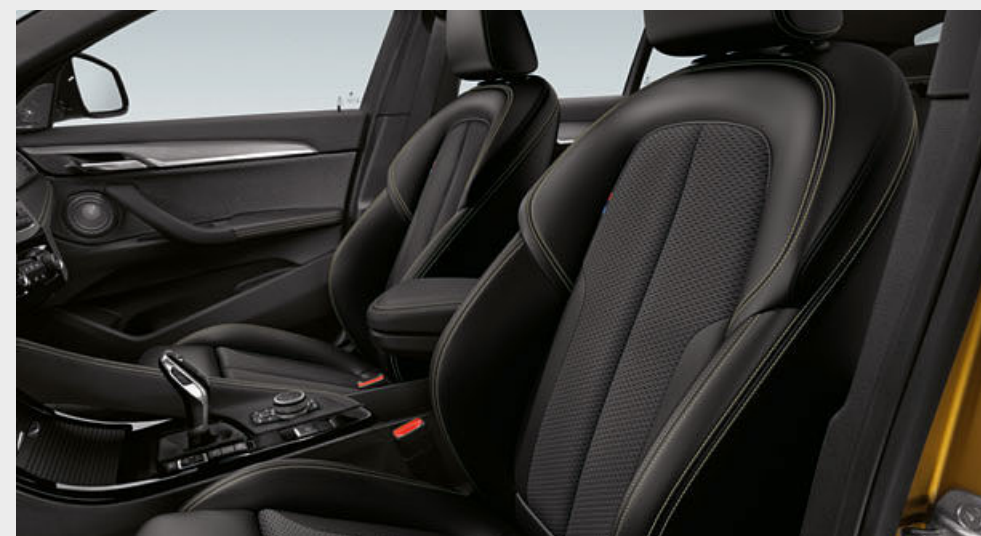

■ The standard Sport seats in Micro Hexagon Alcantara Anthracite cloth with Yellow accents are perfectly matched to the optional Galvanic Gold metallic exterior paint finish and, along with other exterior finishes, further underline the sporty interior styling.

Model M Sport X exterior equipment¹:

- M Sport X exterior package including front apron with insert in Frozen Grey metallic, specially designed air inlets and side skirts in Frozen Grey metallic with inserts in the body colour, wheel arch trim, claddings and rear apron diffuser insert in Frozen Grey metallic
- 19" M light alloy wheels Y-spoke style 722 M with run-flat properties, alternatively
- 20" M light alloy wheels Double-spoke style 717 M with run-flat properties
- Lowered M Sport suspension, alternatively lowered Adaptive suspension or Standard suspension
- M Sport steering
- BMW Individual high-gloss Shadow Line, alternatively BMW Individual Exterior Line Aluminium satinated
- M designation on the sides
- Exclusive paintwork in Misano Blue metallic; other paintworks available

Model M Sport X interior equipment¹:

- M door sill finishers front and M driver footrest
- Sport seats for driver and front passenger in cloth 'Micro Hexagon' Sensatec Black with Yellow highlight; other upholsteries available
- M Leather steering wheel
- Vehicle key with exclusive M designation
- BMW Individual headliner anthracite
- Interior trim finishers in Aluminium Hexagon Anthracite, other trims available
- Shortened gear lever with M designation²
- Lights package
- Exclusive LED optical fibre in the door trims



■ 19" M light alloy wheels Y-spoke style 722 M, Orbit Grey, gloss-lathed with runflat tyres, wheel size 8J x 19 with 225/45 R19 tyres.



□ 20" M light alloy wheels Double-spoke style 717 M, Orbit Grey matt, gloss-lathed with runflat tyres, wheel size 8J x 20 with 225/40 R20 tyres.

¹ The following features are additionally available as an option: M Sport brake, M Sport seats and M* seat belts.

² Only available in conjunction with manual transmission.

*The availability of some equipment features and functions depends on engine variants or additional options. The market and production availability may vary. You can find detailed information about terms, standard and optional equipment at www.bmw.com or from your BMW Partner.

The Standard and Optional equipment may differ between countries. Please consult your local BMW partner for more information.

BMW M.

The BMW X2 M35i.

Self-confident every metre of the way: Already on the outside, the BMW X2 M35i looks particularly dynamic and extroverted thanks to mirror caps in Cerium Grey and the 20" M light alloy wheels 721 M. The unique design continues in the interior: The modern dashboard includes the clearly drawn instrument cluster, the Navigation system Plus^{1,*} and the BMW Head-Up Display^{1,2*}. The M Sport seats^{1,*} for driver and front passenger feature perfect support and lend the interior a sporty appearance. In this way, the BMW X2 M35i clearly states that it follows no rules – but makes its own.



The M Sport seats^{1,*} with integrated headrests offer the driver and front passenger excellent support with their deep seats and high side bolsters, also during fast driving on changing bends.



The compact M Leather steering wheel in the particularly narrow M specific three-spoke design impresses with a phenomenal feel, a sporty look and very modern technology.



The mirror caps of the exterior mirrors in Cerium Grey emphasise the strong personality of the new BMW X2 M35i.



20" M light alloy wheels Double-spoke style 721 M¹, Cerium Grey, burnished, with runflat tyres, wheel size 8J x 20 with 225/40 R20 tyres.

¹ Available as optional equipment.

² The information in the BMW Head-Up Display is not fully visible when viewed through polarised sunglasses. Content shown will depend on the equipment options chosen. Further optional equipment is required to display specific items.

* The availability of some equipment features and functions depends on engine variants or additional options. The market and production availability may vary. You can find detailed information about terms, standard and optional equipment at www.bmw.com or from your BMW Partner.

ADDITIONAL EQUIPMENT.

Discover more with the new BMW catalogue app. Now available for your smartphone and tablet.

■ Standard equipment □ Optional equipment



- The LED headlights with extended contents offer bi-LED light for low and high-beam headlights as well as LED cornering and bending lights.
- The light generated by the LED fog lights is very similar to daylight and enables the driver to see better and drive more safely in inclement weather.



- The M rear spoiler* emphasises the car's athletic silhouette and reduces unwanted lift. By producing downforce on the rear axle, it provides the vehicle with greater driving stability.



- BMW kidney grille with eight slats per side, facings in high-gloss Black and grille frame in high-gloss Chrome.

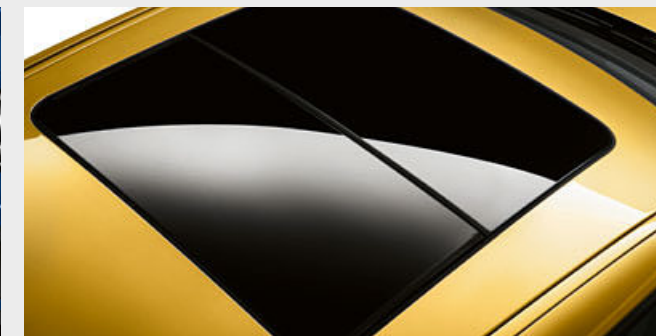

- When open, the Panorama glass roof provides a great deal of fresh air. Closed, it creates a bright, light-flooded atmosphere in the interior. It opens and closes completely automatically at the push of a button or with the car key and is equipped with slide and lift functions, a roller sunblind and wind deflector.



- The two-part rear lights, including tail light and braking light with LED technology, are equipped with a dynamic brake light function.

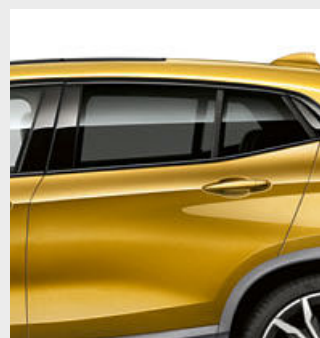

- The Sun protection glazing for the rear window and tinted rear side windows reduces unwanted warming of the interior.



- The wing mirror caps are painted in high-gloss Black instead of the body colour. They emphasise the car's athletic look and create an individual appearance.



- The premium-quality BMW Individual roof rails high-gloss Shadow Line is the key to a multifunctional BMW roof rack unit.



- The Roof rails in Aluminium satinated provide the base for a multifunctional BMW roof rack unit.



- The Comfort access system* allows passengers to enter the car via the front doors and to open the tailgate without having to actively use the key.



- The Automatic tailgate operation opens and closes the tailgate electrically. Simply press a button.



- BMW Individual high-gloss Shadow Line features numerous equipment and design details in Black high-gloss to boost the vehicle's athletic and elegant character. These include the side window frame surrounds, the window recess finishers, the B-pillar trim, as well as details on the C-pillars and the exterior mirrors.



- The BMW Individual Exterior Line features elegant accents, with trim strips for the side window frames, window recess finishers, and surrounds on the C-pillars in satinated Aluminium. Along with the roof mouldings in body colour, the exterior mirror frames, bases and triangles and the trim on the B-pillars are in a stylish contrasting Black high-gloss.



- Two easily visible, single-flow, round tailpipes* with a diameter of 90 millimetres are located on each side at the rear. The tailpipe trim is Chrome high-gloss.



- The high-performance M Sport brake¹ is distinguished by exclusive dark blue brake callipers with M lettering and outstanding braking performance.



- When not in use, the removable ball head of the trailer tow hitch has no negative impact on the sporty appearance of the rear.

The Standard and Optional equipment may differ between countries. Please consult your local BMW partner for more information.

¹ Available as standard for BMW X2 M35i.

*The availability of some equipment features and functions depends on engine variants or additional options. The market and production availability may vary. You can find detailed information about terms, standard and optional equipment at www.bmw.com or from your BMW Partner.

ADDITIONAL EQUIPMENT.

Discover more with the new BMW catalogue app. Now available for your smartphone and tablet.

■ Standard equipment □ Optional equipment

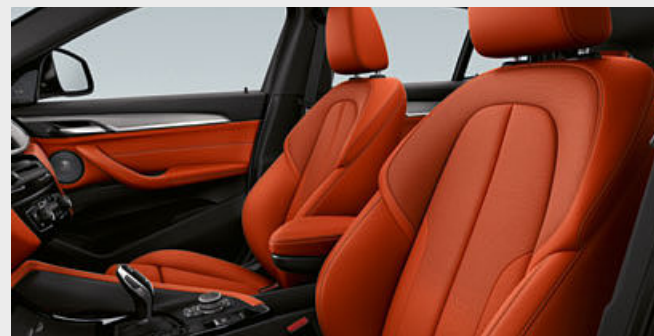

□ The sport seats* have high seat and backrest bolsters, providing optimal support for the driver and front passenger even during athletic driving on bends. In contrast to the standard seats, their seat angle, seat depth, thigh rests and the armrest width on the driver's seat can be individually adjusted. Their special design highlights the vehicle's athletic capabilities.



□ The M Sport seats* with integrated headrests offer the driver and front passenger excellent support with their deep seats and high side bolsters, also during fast driving on changing bends.

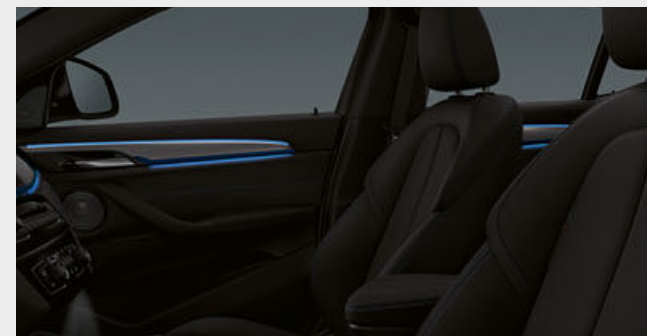

□ The atmospheric Lights package contains various LED lights and yields an ambience of pure quality. The driver is welcomed with an impressive welcome-illumination with exterior LEDs. Ambient light atmospherically lights up the interior with a stylish combination of direct and indirect lights.*



■ The Storage compartment package offers additional storage options in the interior and luggage compartment. Among other things, it includes a centre armrest for the rear seat with two cupholders, and nets on the front-seat backrests. A double USB port in the rear centre console and a 12V socket in the luggage compartment offer additional connection options for electrical devices.



□ M Leather steering wheel including multifunction buttons, steering wheel rim in leather "Walknappa" Black with contoured thumb rests.

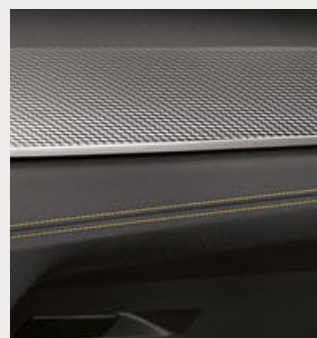

■ Contrast stitching in the centre console and the instrument panel in all upholstery variants. The contrast and decorative stitching are each perfectly colour-matched to the interior.



□ The Seat heating for driver and front passenger allows for heating of the entire seat base and backrest.



□ The electrical seat adjustment allows preferred settings for the seat and the exterior mirrors to be saved using the memory function.



□ The Harman Kardon surround sound system, with twelve speakers optimally designed to suit the interior's sound characteristics, guarantees an exceptional music experience. Tweeters and subwoofers deliver a brilliant, powerful range of sound. Elegant aluminium loudspeaker fronts feature „Harman/Kardon“ lettering for a high-class look.



□ The HiFi loudspeaker system with 205 watts amplifier output and seven speakers evenly distributes the sound in the interior of the car.



□ Automatic air conditioning with two-zone control includes Automatic Air Recirculation (AAR) with a micro active carbon filter, as well as fogging and solar sensors.



□ The BMW Individual headliner anthracite with black-lined components gives the interior an athletic flair.



□ The 8-speed Steptronic Sport transmission* offers incredibly sporty gear changes. Whether automatic or manual using gearshift paddles or gear lever.



□ The lumbar support for the driver and front passenger seats can be adjusted both vertically and laterally, allowing for an orthopaedically optimised seating position.



■ The through-loading system includes rear seat backrests that can be flexibly divided in a 40:20:40 ratio.

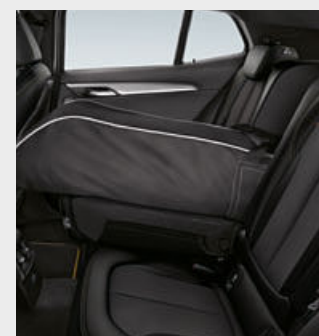

□ The Ski and snowboard bag makes it possible to transport skis or snowboards cleanly and safely.

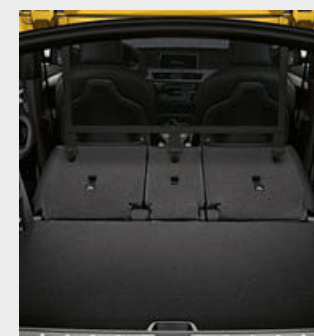

□ The Luggage-compartment separating net can be attached behind the rear or front seats to prevent objects from falling forwards into the passenger area.



■ Various storage options increase the level of comfort and ensure that the interior remains tidy.



□ Interior and driver-side exterior mirrors with automatic anti-dazzle function, including electric fold-in function for the exterior mirrors and automatic curb parking function for the front passenger exterior mirror.

ADDITIONAL EQUIPMENT.

Discover more with the new BMW catalogue app. Now available for your smartphone and tablet.

■ Standard equipment □ Optional equipment



□ Navigation Plus* features a BMW Head-Up Display¹, an iDrive Controller, a built-in 10.25" touch display and an instrument cluster with high-resolution 5.7" TFT display. The system is operated intuitively using either the iDrive Controller, the direct menu control buttons and eight functional bookmarks, Intelligent Voice Control or the touchscreen with interactive tiles.



□ The full-colour BMW Head-Up Display¹ * projects information relevant to the journey directly into the driver's field of vision, thereby allowing them to fully concentrate on driving. The display includes information such as the current speed, navigation directions, Speed Limit Info incl. no-overtaking indicator, along with telephone and entertainment lists.

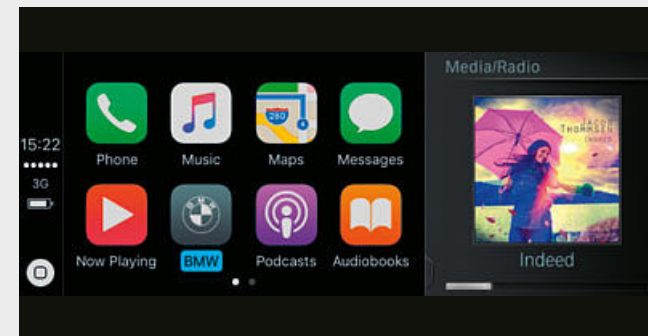

□ Why go without the features of your iPhone in your BMW when you can continue operating it as usual? The preparation for Apple CarPlay^{®3} * gives you remote access to telephony as well as apps like iMessage, WhatsApp, TuneIn, Spotify and Apple Music. You can also use the voice button on the steering wheel to access Siri, Apple's voice assistant.



□ The "Share live trip status"^{**} function allows you to securely share your time of arrival and current location with friends and family during a trip. The recipient receives a link to a website that displays the destination and current location of the vehicle on a map.



■ The radio, telephone and audio streaming functions can all be used with the „Media“ communications and information system.



□ Telephony with wireless charging offers a comprehensive telephony package with Bluetooth connectivity and the technical capacity for a WiFi hotspot².



□ The extended contents of the instrument cluster* in Black Panel technology include a larger high-resolution TFT display which can show navigation tips, operational messages and various vehicle information such as lists of radio stations, music titles or contact information.



□ The Driving Assistant⁴ * safety package draws the driver's attention to an unintentional lane change or possible collision and brakes automatically in the event of an emergency.

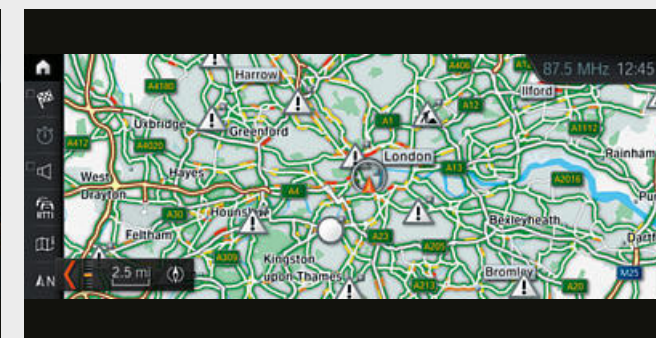

□ From traffic jams to roadworks, Real Time Traffic Information* will find the quickest route to your destination, warning you of any hazards on the way.

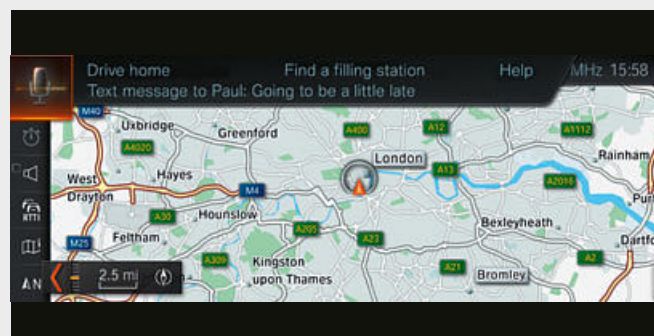

□ Intelligent Voice Assistant* understands natural speech and optimises recognition rate over a large range of individual and situational variations thanks to Offboard voice processing*. It also understands linguistic varieties, dialects and jargon. This enables a substantially greater range of possibilities when dictating text messages or emails.

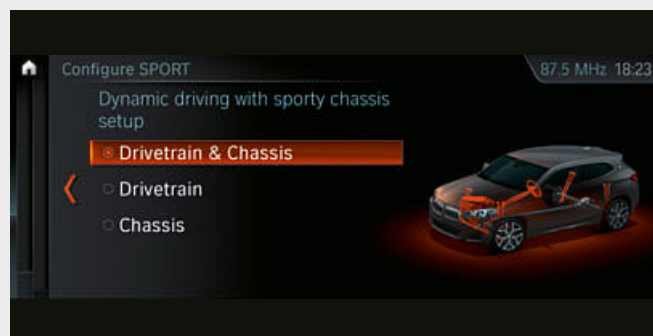

□ Dynamic Damper Control with a suspension lowering of ten millimetres combines driving dynamics and comfort with a high level of safety. The driver has the option of preselecting the damper characteristics via the Driving Experience Control. Along with the standard COMFORT setting, SPORT mode is also available.

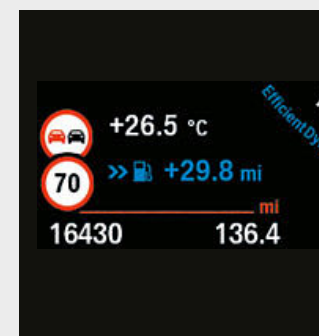

□ The intelligent Speed Limit Info¹² system detects speed limits using a camera and compares the information with navigation system data to establish currently applicable restrictions.



□ The Driving Assistant Plus⁴ * offers warning and collision safeguard functions, camera-based cruise control and the Traffic jam assistant.

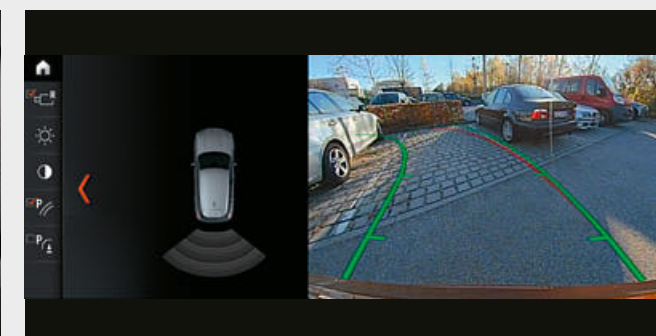

□ The Rear view camera* enables improved orientation when reversing at speeds below 15 km/h, for example when parking. It shows the area behind the car on the Control Display. Interactive track lines for measuring distance and turning circles assist you when manoeuvring. Obstacles are marked in colour.

¹ The information in the BMW Head-Up Display is not fully visible when viewed through polarised sunglasses. The exact content shown will depend on the equipment options chosen. Further optional equipment is required for content to be displayed.
² Supports inductive charging for Qi-compatible mobile phones. Special charging cases are available from Original BMW Accessories for selected smartphones that do not support the Qi standard for inductive charging. The WiFi hotspot fulfils all in-vehicle requirements for use of the internet with the maximum LTE standard. Usage is subject to cost.

³ Apple CarPlay[®] compatibility and supported functions depend on the model year and the software installed on the iPhone[®]. When the Apple CarPlay[®] preparation is in use, selected vehicle data is transferred to the phone. The mobile phone manufacturer is responsible for any further processing of the data.

⁴ Function may be limited in darkness, fog or bright glare.

* The availability of some equipment features and functions depends on engine variants or additional options. The market and production availability may vary. You can find detailed information about terms, standard and optional equipment at www.bmw.com or from your BMW Partner.

Some ConnectedDrive Services may differ between countries. Please consult your local BMW partner for more information. The Standard and Optional equipment may differ between countries. Please consult your local BMW partner for more information.

EXTERIOR COLOURS.

Discover more with the new BMW catalogue app. Now available for your smartphone and tablet.

■ Standard equipment □ Optional equipment

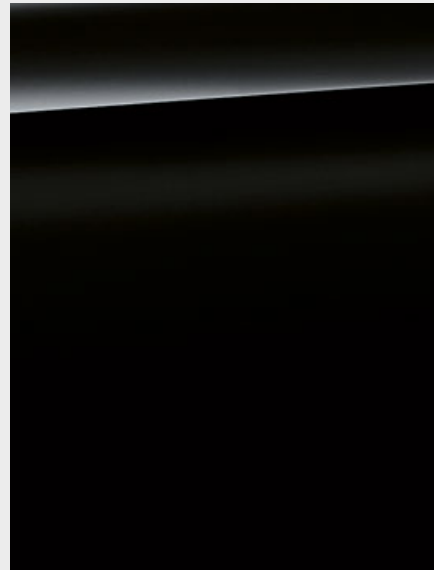

■ Non-metallic 668 Black



□ Non-metallic 300 Alpine White¹

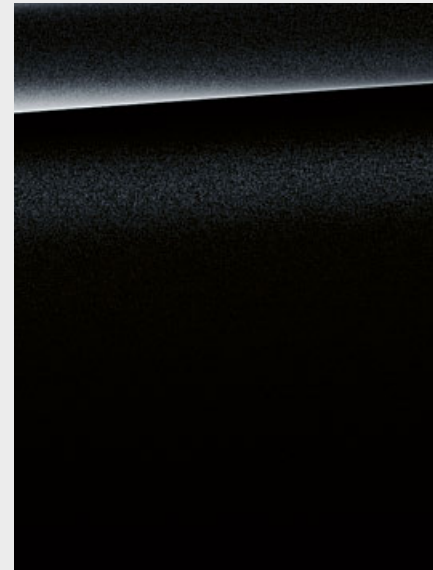

□ Metallic 475 Sapphire Black²



□ Metallic A96 Mineral White



□ Metallic A83 Glacier Silver

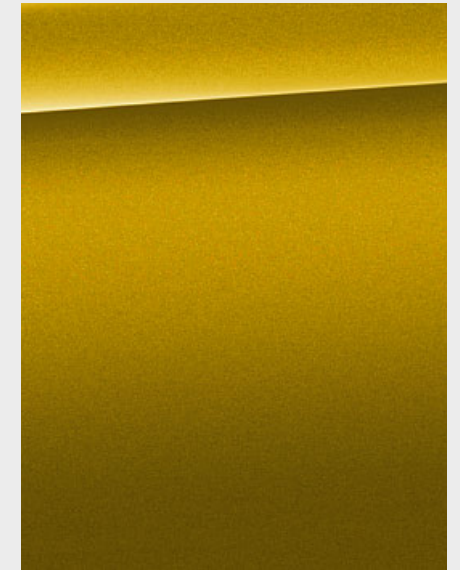

□ Metallic C1P Galvanic Gold²

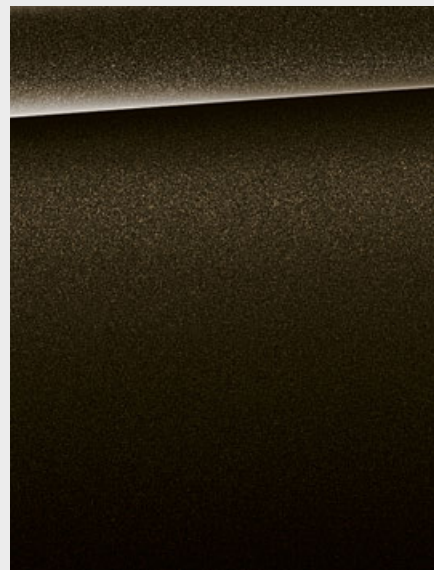

□ Metallic C07 Sparkling Storm brilliant effect³



□ Metallic C10 Mediterranean Blue³

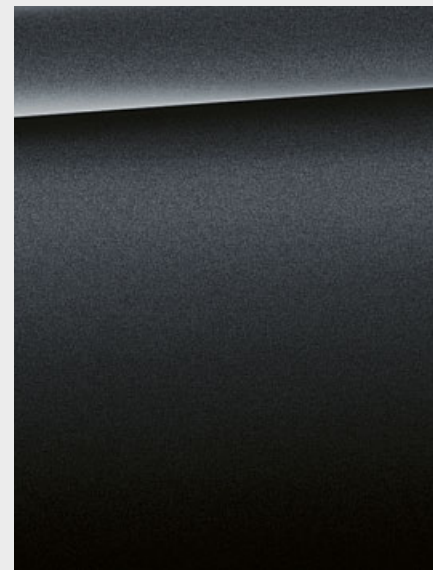

□ Metallic B39 Mineral Grey²

M SPORT PACKAGE M SPORT X PACKAGE

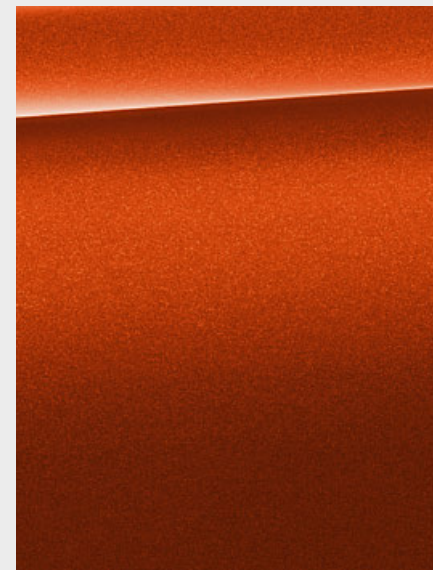

□ Metallic C1X Sunset Orange²



□ Metallic C1D Misano Blue⁴

[Colour samples] These colour samples are intended as an initial guide to the colours and materials available for your BMW. However, experience has shown that printed versions of paint, upholstery and interior trim colours cannot in all cases faithfully reproduce the

appearance of the original colour. Please discuss your preferred colour choices with your BMW partner or dealership. There you can also see original samples and be assisted with special requests.

¹ Available as standard for M Sport package, M Sport X package and BMW M35i.
² Optionally also available for M Sport package, M Sport X package and BMW M35i.
³ Also optionally available for M Sport X package.
⁴ Exclusively available in conjunction with M Sport package or M Sport X package.

The Standard and Optional equipment may differ between countries. Please consult your local BMW partner for more information.

Discover more with the new BMW catalogue app. Now available for your smartphone and tablet.

■ Standard equipment □ Optional equipment

CLOTH

Available with

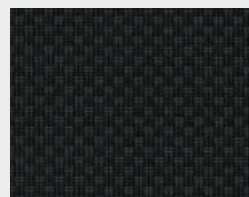

■ Base

Cloth 'Grid'
EGAT Anthracite*



□ Base

Cloth 'Race'
ERL1 Anthracite,
Grey highlight*

STOFF- ALCANTARA- KOMBINATION

Available with

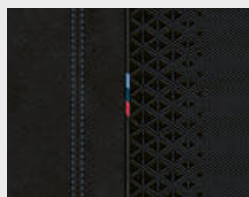

□ M Sport package
□ M Sport X package

Cloth 'Trigon'
HLSW Alcantara
Black with blue
highlights*

INTERIOR TRIMS

Available with

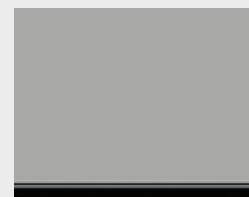

■ Base

4FS Oxide Silver
dark matt, highlight
trim finisher Black
high-gloss



■ M Sport package
■ M Sport X package

4WP Aluminium
Hexagon Anthracite,
highlight trim finisher
Pearl Chrome¹



□ Base
□ M Sport package
□ M Sport X package

4F7 Fine-wood trim
oak grain matt,
highlight trim finisher
Pearl Chrome



■ M Sport package
■ M Sport X package

4WF Aluminium
Hexagon with matt
Blue accent line¹



□ Base
□ M Sport package
□ M Sport X package

4LR Fine-wood trim
Fineline Stream,
highlight trim
finishers Pearl
Chrome

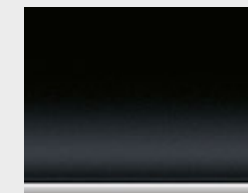

□ Base
■ M Sport package
■ M Sport X package

4LU Black high-
gloss, highlight trim
finisher Pearl
Chrome¹

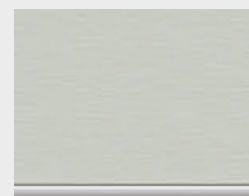

□ Base
■ M Sport package
■ M Sport X package

4LS Aluminium,
finely brushed
lengthwise, highlight
trim finishers Pearl
Chrome¹

SENSATEC

Available with

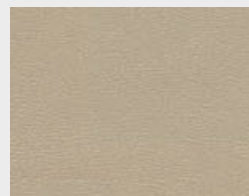

□ Base
□ M Sport package
□ M Sport X package

Sensatec
KCCX Oyster¹

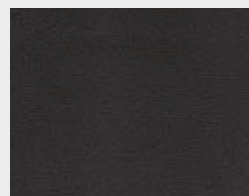

□ Base
□ M Sport package
□ M Sport X package

Sensatec
KCSW Black¹

LEATHER

Available with



□ Base
□ M Sport package
□ M Sport X package

Leather 'Dakota'
PDSW with
perforations Black
and Grey highlight*



□ Base
□ M Sport package
□ M Sport X package

Leather 'Dakota'
PDMZ with
perforations Mocha,
Walnut highlight*



□ Base
□ M Sport package
□ M Sport X package

Leather 'Dakota'
PDOA with
perforations Oyster,
Grey highlight*

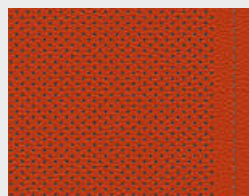

□ Base
□ M Sport package
□ M Sport X package

Leather 'Dakota'
PDFM with
perforations Magma
Red, Grey highlight*



□ M Sport package
□ M Sport X package

Leather 'Dakota'
PDN4 with
perforations Black,
Blue highlight*

CLOTH-SENSATEC COMBINATION

Available with

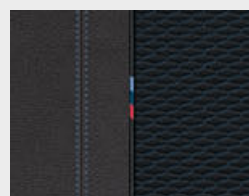

■ M Sport package
■ M Sport X package

Cloth 'Micro
Hexagon' HKSW
Sensatec Black,
Blue highlight¹

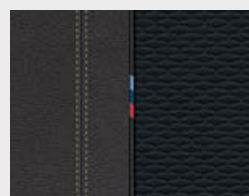

■ M Sport package
■ M Sport X package

Cloth 'Micro
Hexagon' HKJJ
Sensatec Black,
Yellow highlight¹

*The availability of some equipment features and functions depends on engine variants or additional options. The market and production availability may vary. You can find detailed information about terms, standard and optional equipment at www.bmw.com or from your BMW Partner.

Please note that even normal long- or short-term use can lead to unrecoverable upholstery damage. This can be caused in particular by non-colourfast clothing. All interior trims apart from 4FS feature an LED light guide in the door trim. Please note that the interior colour depends on the selected upholstery colour.

The Standard and Optional equipment may differ between countries. Please consult your local BMW partner for more information.

¹ Available as standard for BMW M35i.

WHEELS AND TYRES.

Discover more with the new BMW catalogue app. Now available for your smartphone and tablet.



■ 17" light alloy wheels V-spoke style 560 in Reflex Silver, wheel size 7.5J x 17 with 225/55 R17 tyres.



□ 17" light alloy wheels Double-spoke style 564 Reflex Silver, wheel size 7.5J x 17 with 225/55 R17 tyres.



□ 18" light alloy wheels Y-spoke style 566, Ferric Grey, gloss-lathed, wheel size 7.5J x 18 with 225/50 R18 tyres.



□ 18" light alloy wheels Double-spoke* style 578 Jet Black with runflat tyres, wheel size 7.5J x 18 with 225/50 R18 tyres.



□ 18" light alloy wheels Y-spoke* style 579 Bicolour Orbit Grey with runflat tyres, gloss-lathed, 7.5J x 18 with 225/50 R18 tyres.



□ 19" light alloy wheels Y-spoke* style 511 Orbit Grey, gloss-lathed with runflat tyres, wheel size 8J x 19 with 225/45 R19 tyres.



■ 19" M light alloy wheels Y-spoke^{2,3,*} style 722 M, Orbit Grey, gloss-lathed with runflat tyres, wheel size 8J x 19 with 225/45 R19 tyres.



■ 19" M light alloy wheels Double-spoke^{2,3,4} style 715 M, Orbit Grey, gloss-lathed with runflat tyres, wheel size 8J x 19 with 225/45 R19 tyres.



□ 20" M light alloy wheels Double-spoke^{2,3,*} style 717 M, Orbit Grey matt, gloss-lathed with runflat tyres, wheel size 8J x 20 with 225/40 R20 tyres.



□ 20" M light alloy wheels Double-spoke^{2,3,*} style 716 M, Jet Black, gloss-lathed with runflat tyres, wheel size 8J x 20 with 225/40 R20 tyres.



□ 20" M light alloy wheels Double-spoke^{1,*} style 721 M with runflat tyres.

¹ Optionally available for BMW X2 M35i.

² Only available in conjunction with M Sport X package.

³ Only available in conjunction with M Sport package.

⁴ Available as standard for M35i.

*The availability of some equipment features and functions depends on engine variants or additional options. The market and production availability may vary. You can find detailed information about terms, standard and optional equipment at www.bmw.com or from your BMW Partner.

ORIGINAL BMW ACCESSORIES.

■ Standard equipment □ Optional equipment ○ Accessories



○ The high-quality 19" light alloy wheels V-spoke style 573 are designed in Bicolor Black, bright turned on the visible side and weight-optimised. Summer complete wheel set with run-flat tyres, wheel size 8J x 19 with tyre size 225/45 R19 92W RSC.



○ The modern roof box in black with titanium silver side panels has a capacity of 420 litres and is compatible with all BMW roof rack systems. Due to the fact that it can be opened from both sides and has triple central locking on each side it is convenient to load and lock for theft protection.



○ In the event of disturbances, the highly sensitive full-HD camera automatically records the situation in front of and behind the car.

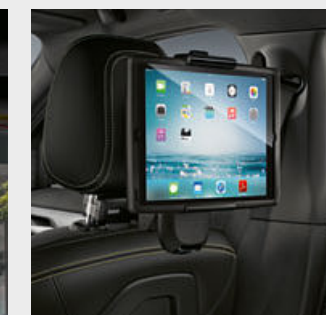

○ Secure base for the Apple iPad® 2, 3 or 4. The holder is snapped into the basic carrier and can be rotated 360° as well as tilted to the desired angle.

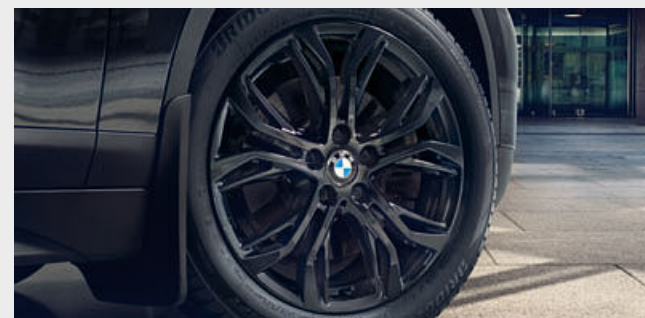

○ The high-quality 18" light alloy wheels, Y-spoke style 566 are designed in black and lend the vehicle a very sporty appearance. TPMS summer complete wheel set with run-flat tyres, wheel size 7.5J x 18 with tyre size 225/50 R18 95W RSC.



○ The durable, anti-slip, water-resistant fitted mat with raised borders on all sides and a shapely design protects the luggage compartment from dirt and moisture. Designed in black with a black X2 inlays that perfectly match the interior.

The Standard and Optional equipment may differ between countries. Please consult your local BMW partner for more information.

Discover the wide range of innovative solutions available for the exterior and interior, communication and information, and for transportation and the luggage compartment. Your BMW Partner is on hand to advise you on the whole range of Original BMW Accessories. For more information, visit www.bmw.com

BMW X2	sDrive18i	sDrive20i	xDrive20i	M35i	sDrive16d ⁷	sDrive18d	xDrive18d	sDrive20d	xDrive20d	xDrive25d
--------	-----------	-----------	-----------	------	------------------------	-----------	-----------	-----------	-----------	-----------

Weight											
Unladen weight EU ¹	kg	1475 [1495]	[1535]	[1625]	[1685]	1550 [1570]	1575 [1610]	1655 [1675]	[1615]	[1675]	[1695]
Maximum permissible weight	kg	1985 [2005]	[2055]	[2145]	[2190]	2015 [2030]	2080 [2115]	2160 [2180]	[2125]	[2190]	[2170]
Permitted load	kg	585 [585]	[595]	[595]	[580]	540 [535]	580 [580]	580 [580]	[585]	[590]	[550]
Permitted trailer load, unbraked ²	kg	725 [725]	[750]	[750]	– ⁶	740 [740]	750 [750]	750 [750]	[750]	[750]	[750]
Permitted trailer load, braked, max. 12% gradient/max. 8% gradient ²	kg	1700/1700 [1700/1700]	[1800/1800]	[2000/2000]	– ⁶	1700/1700 [1700/1700]	1800/1800 [1800/1800]	1800/1800 [1800/1800]	[1800/1800]	[2000/2000]	[2000/2000]
Luggage compartment capacity	l	470–1355	470–1355	470–1355	470–1355	470–1355	470–1355	470–1355	470–1355	470–1355	470–1355

Engine ^{3,4}											
Cylinders/valves		3/4	4/4	4/4	4/4	3/4	4/4	4/4	4/4	4/4	4/4
Capacity	cc	1499	1998	1998	1998	1496	1995	1995	1995	1995	1995
Rated output/ rated engine speed	kW (hp)/ r/min	103 (140)/ 4600–6500	141 (192)/ 5000–6000	141 (192)/ 5000–6000	225 (306)/ 5000–6250	85 (116)/ 4000	110 (150)/ 4000	110 (150)/ 4000	140 (190)/ 4000	140 (190)/ 4000	170 (231)/ 4400–4400
Max. torque/engine speed	Nm/r/min	220/ 1480–4200	280/ 1350–4600	280/ 1350–4600	450/ 1750–4500	270/ 1750–2250	350/ 1750–2500	350/ 1750–2500	400/ 1750–2500	400/ 1750–2500	450/ 1500–3000

Power transmission											
Type of drive		Front-wheel	Front-wheel	All-wheel	All-wheel	Front-wheel	Front-wheel	All-wheel	Front-wheel	All-wheel	All-wheel
Standard transmission		6-speed manual	Seven-speed DCT	8-speed Steptronic	8-speed Steptronic	6-speed manual	6-speed manual	6-speed manual	8-speed Steptronic	8-speed Steptronic	8-speed Steptronic

Performance											
Top speed	km/h	205 [205]	[227]	[224]	[250] ⁵	192 [192]	207 [207]	206 [206]	[224]	[221]	[237]
Acceleration 0–100 km/h	s	9.6 [9.6]	[7.7]	[7.4]	[4.9]	11.5 [11.5]	9.3 [9.3]	9.2 [9.4]	[7.9]	[7.7]	[6.6]

Consumption ^{3,4} – all engines conform to the EU6 standard											
Urban	l/100 km	6.9 [6.9–7.0]	[7.4–7.8]	[7.5–7.7]	[8.3–8.7]	– ⁶	5.3 [5.1–5.2]	5.7–6.0 [5.2–5.5]	[4.8–5.3]	[5.4]	– ⁶
Extra-urban	l/100 km	4.9–5.1 [4.9–5.1]	[5.0–5.4]	[5.8–6.1]	[6.1]	– ⁶	4.1–4.2 [4.1–4.4]	4.4–4.7 [4.4–4.6]	[4.1–4.3]	[4.3–4.5]	– ⁶
Combined	l/100 km	5.6–5.8 [5.6–5.8]	[5.9–6.3]	[6.5–6.7]	[6.9–7.1]	– ⁶	4.5–4.6 [4.5–4.7]	4.9–5.2 [4.7–4.9]	[4.4–4.7]	[4.7–4.9]	– ⁶
Exhaust emissions standard (type-certified)		EU6d-temp [EU6d-temp]	[EU6d-temp]	[EU6d-temp]	[EU6d-temp]	EU6d [EU6d]	EU6d-temp [EU6d-temp]	EU6d-temp [EU6d-temp]	[EU6d-temp]	[EU6d-temp]	[EU6d]
Combined CO ₂ emissions	g/km	129–132 [129–133]	[135–143]	[147–152]	[158–161]	– ⁶	119–121 [118–124]	128–137 [123–130]	[115–123]	[124–128]	– ⁶
Tank capacity, approx. Serie	l	51	51	61	61	51	51	51	51	51	51

Wheels/tyres											
Tyre dimensions		225/55 R17 97W	225/55 R17 97W	225/55 R17 97W	225/45 R19 92W	225/55 R17 97W	225/55 R17 97W	225/55 R17 97W	225/55 R17 97W	225/55 R17 97W	225/55 R17 97W
Wheel dimensions		7.5 J x 17	7.5 J x 17	7.5 J x 17	8 J x 19	7.5 J x 17	7.5 J x 17	7.5 J x 17	7.5 J x 17	7.5 J x 17	7.5 J x 17
Material		Light alloy	Light alloy	Light alloy	Light alloy	Light alloy	Light alloy	Light alloy	Light alloy	Light alloy	Light alloy

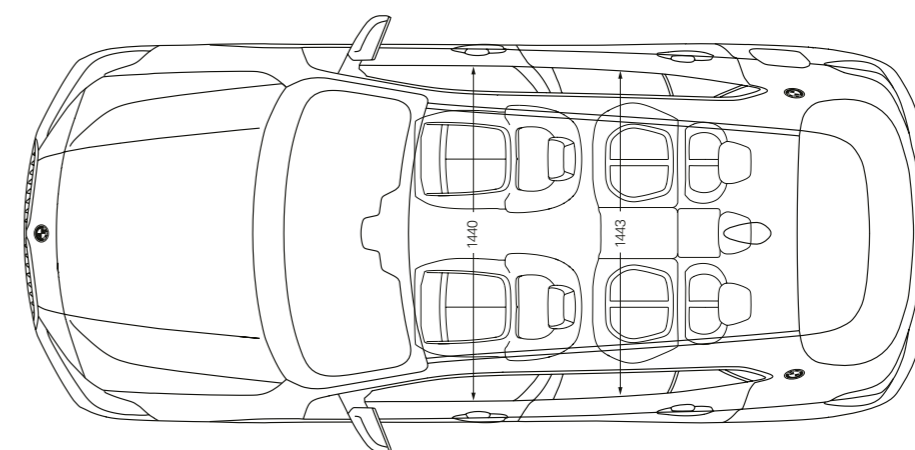
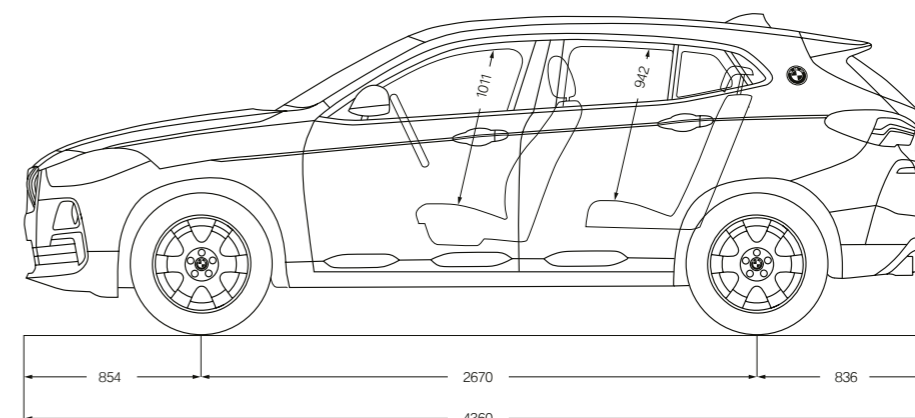
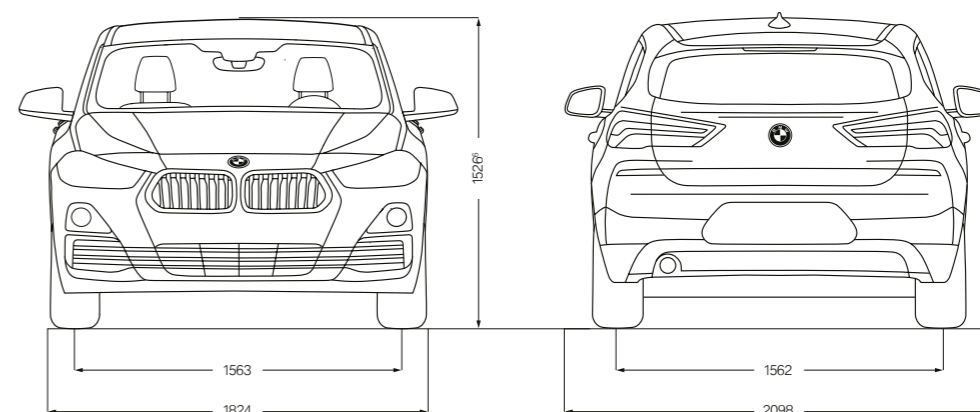

¹ The EC unladen weight refers to a vehicle with standard equipment and does not include any optional extras. The unladen weight includes a 90% full tank and a driver weight of 75 kg. Optional equipment may affect the weight of the vehicle, the payload and the top speed if the selected equipment has an impact on the vehicle's aerodynamics.

² The actual total weight of the trailer must not exceed the maximum trailer load, taking into account the maximum tow bar download.

³ Performance data of petrol engines apply to vehicles using RON 98 fuel. Fuel consumption data apply to vehicles using reference fuels in accordance with EU Regulation 2007/715. Unleaded RON 91 and higher with a maximum ethanol content of 10% (E10) may also be used. BMW recommends RON 95 super unleaded petrol.

⁴ The data for fuel consumption, CO₂ emissions and energy consumption are determined in accordance with the measurements processes as defined by European Regulation (EU) 2007/715 in the applicable version. Data refer to a vehicle with base-level equipment in Germany, and the ranges account for differences according to the selected wheel and tyre size and the optional equipment and may change during the configuration process. Figures have been determined on the basis of the new WLTP test cycle and have been converted back into NEDC figures for comparability. [For these vehicles, values other than those specified here may apply for the assessment of taxes and other vehicle-related charges that are (also) based on CO₂ emissions.]

⁵ Electronically limited.

⁶ Provisional figures; any missing figures were unavailable at the time of publication.

⁷ This engine version is not available in all countries. Please contact your local BMW partner for more information.

Figures in [] are for vehicles with Steptronic transmission.

BMW X2 xDRIVE20d WITH M SPORT X PACKAGE:

BMW TwinPower Turbo four-cylinder diesel engine, 140 kW (190 hp), 20" M light alloy wheels Double-spoke style 717 M, exterior colour in Galvanic Gold metallic, Sport seats in cloth 'Micro Hexagon' Sensatec Black with Yellow highlight, interior trim finishers in Aluminium Hexagon Anthracite.

The models illustrated in this brochure show the equipment and configuration options (standard and optional) for vehicles produced by BMW AG for the German market. Alterations in standard and optional equipment and the configurations available for the different models, as described in this brochure, may occur after 03/18/2019, the date when this brochure went to press, or according to the specific requirements of other markets. Your local BMW Partner is available to provide further details. Subject to change in design and equipment.

© BMW AG, Munich, Germany. Not to be reproduced wholly or in part without prior written permission of BMW AG, Munich.

411 002 203 20 2 2019 CB. Printed in Germany 2019.